

DRAWING NUMBER: 05041-2533	12/21/2015
TITLE: PR C4 CAB	1 OF 2

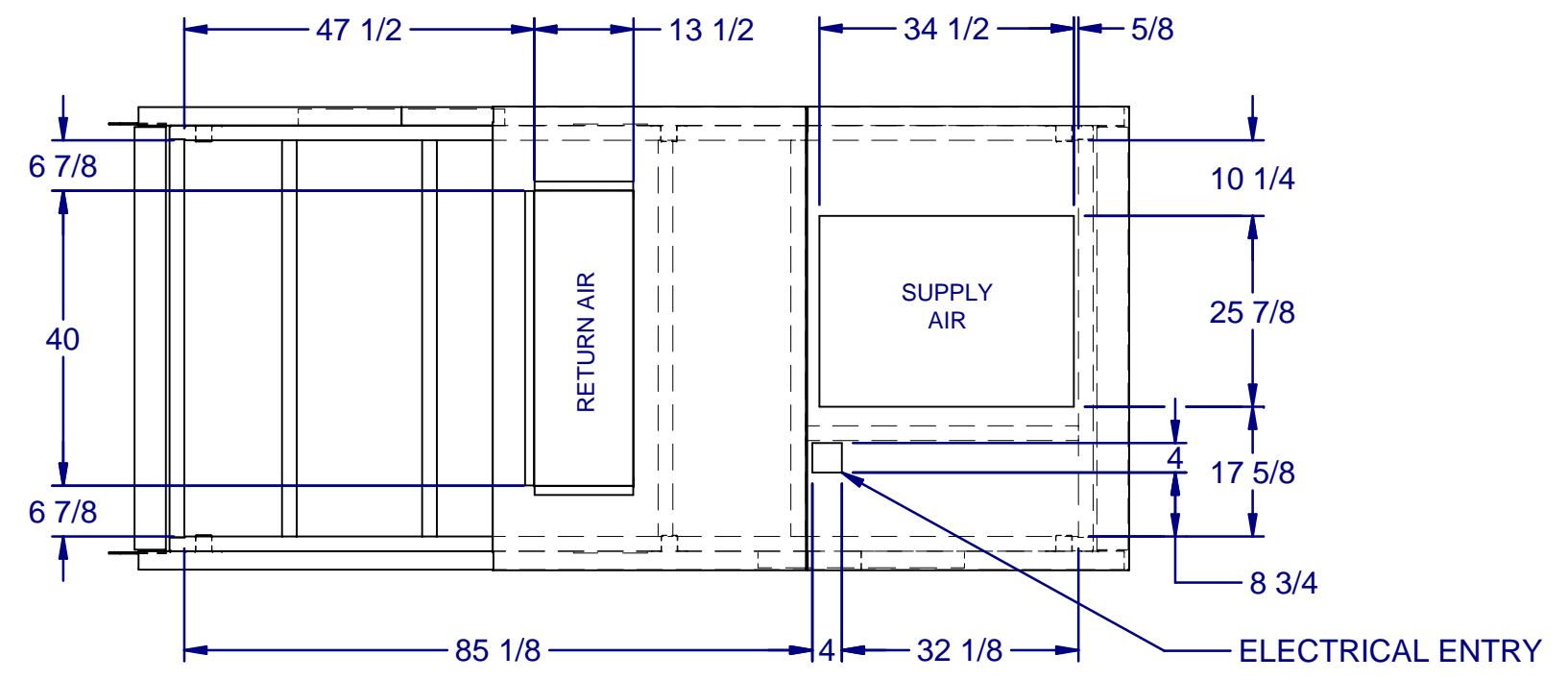
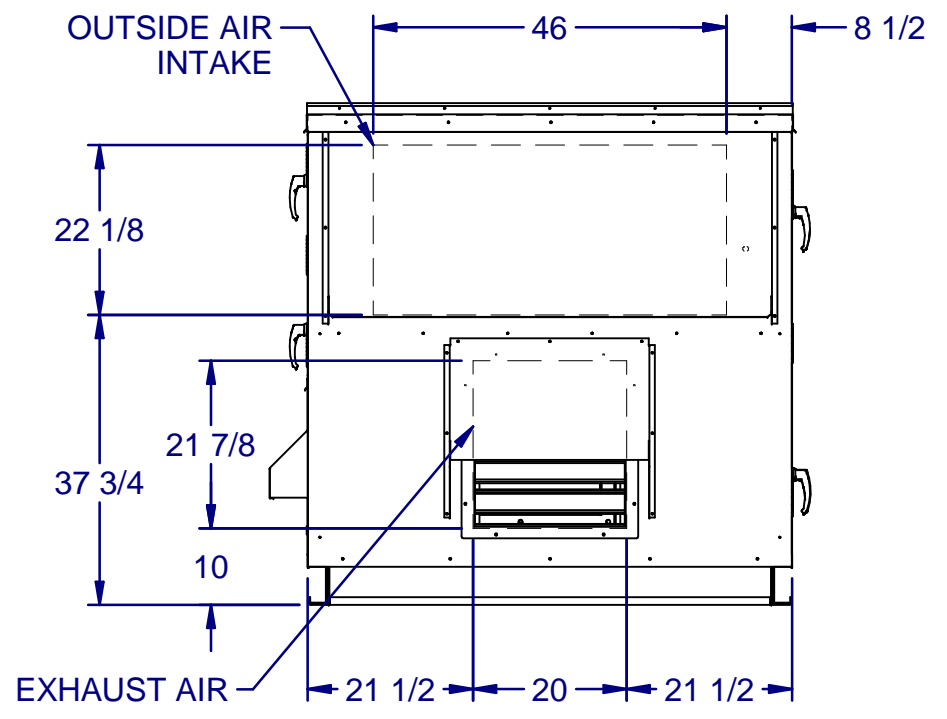
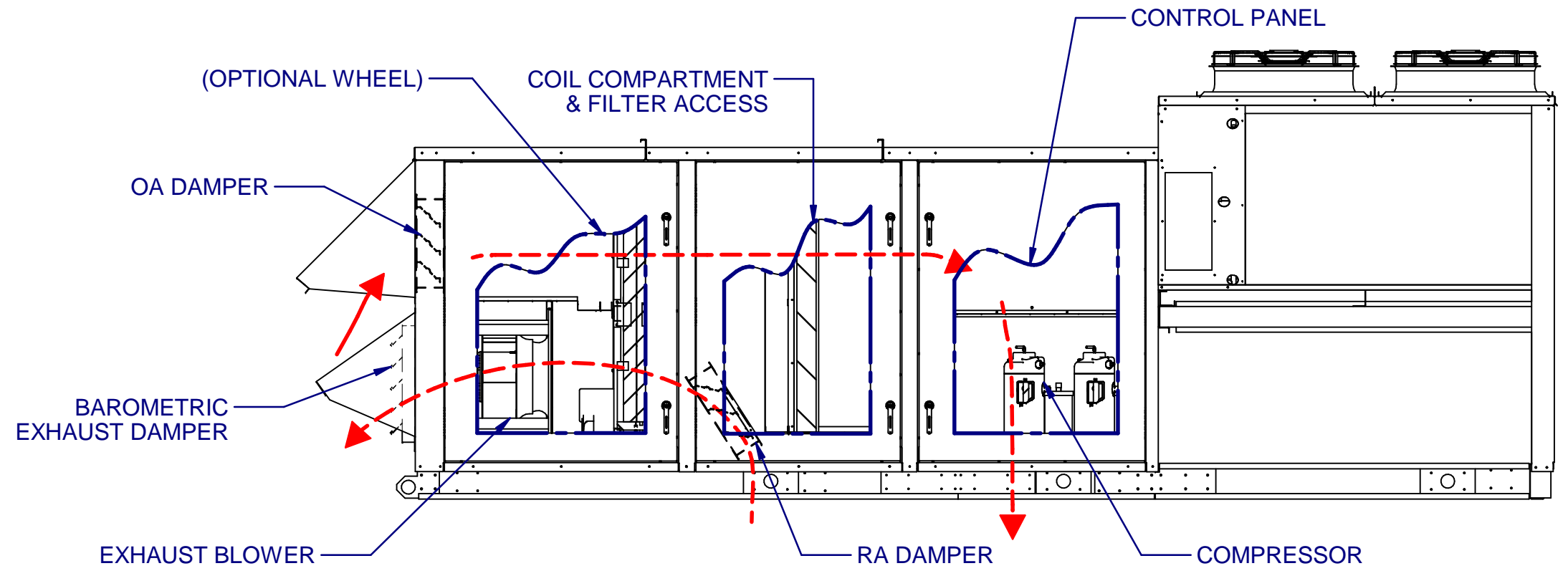

TOP PLAN VIEW
CONDENSING SIDE
NOT SHOWN

DRAWING NUMBER: 05041-2533	12/21/2015
TITLE: PR C4 CAB	2 OF 2