

100% OUTSIDE AIR WITH RECIRCULATING OPTION OR MIXED AIR

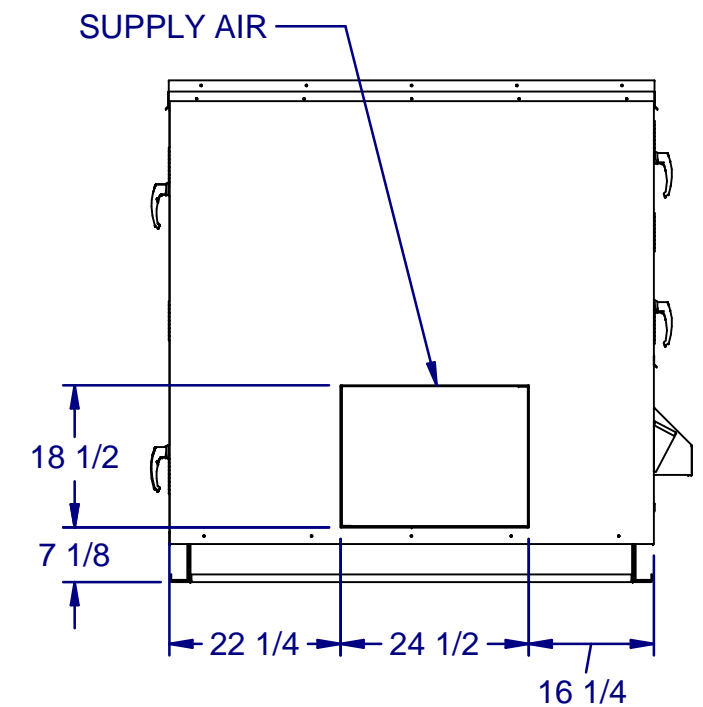
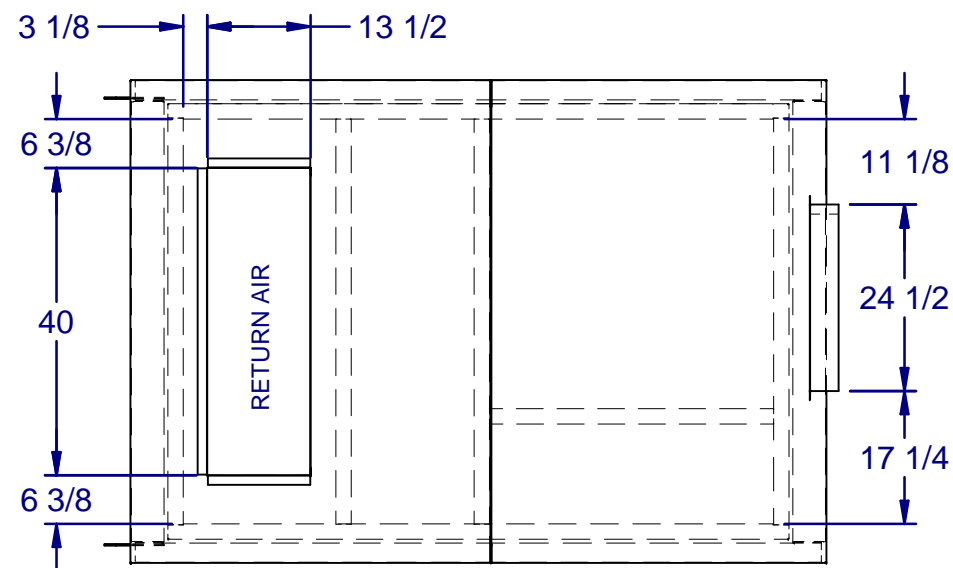
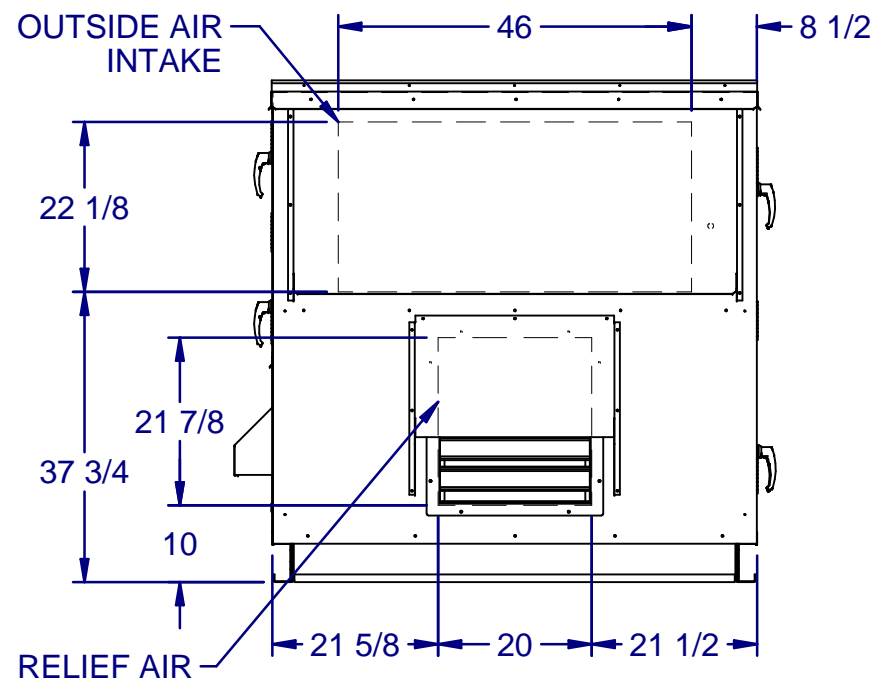
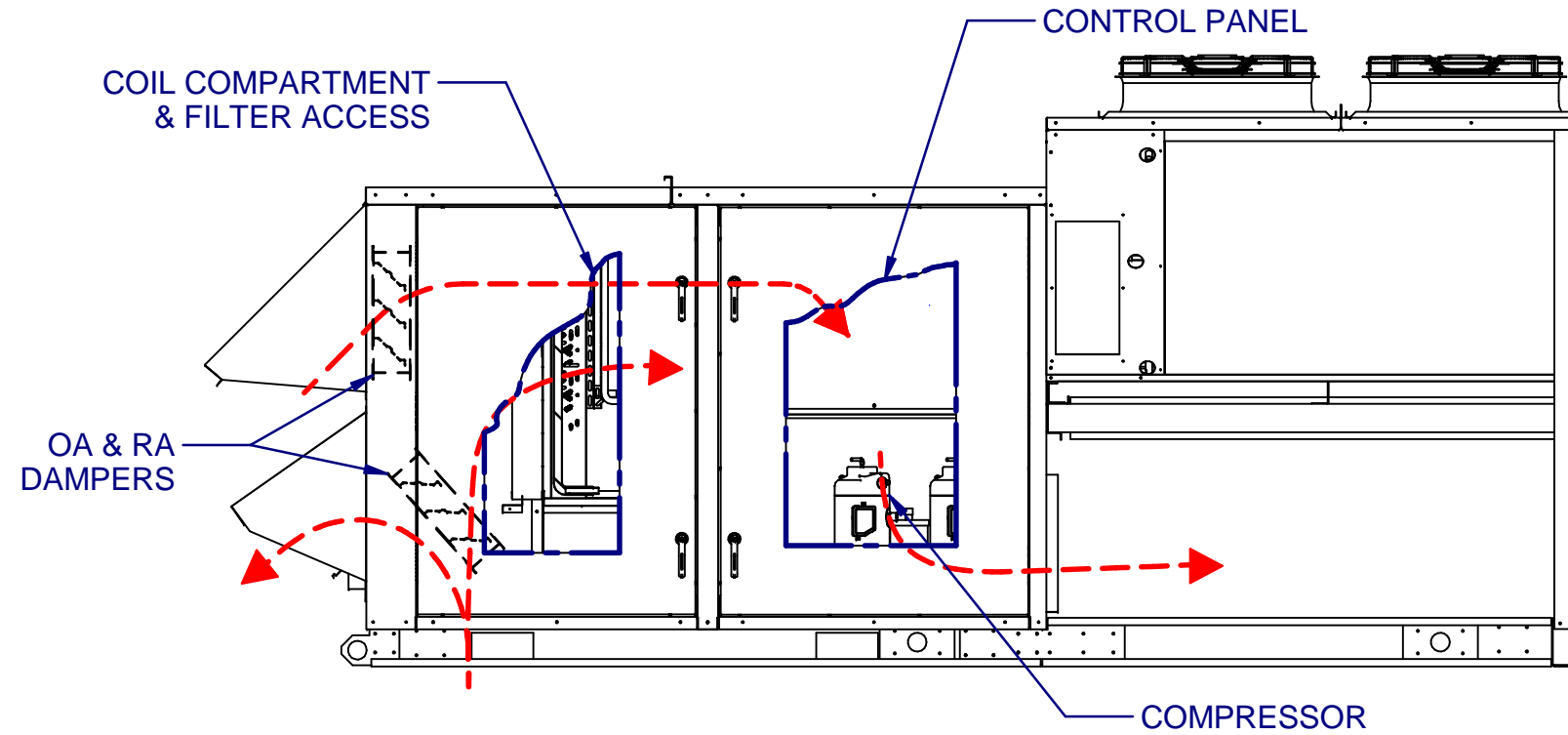

TOP PLAN VIEW
CONDENSING SIDE
NOT SHOWN

DRAWING NUMBER: 05041-2544-3	12/21/2015
TITLE: PR C4 CAB NO EXH HOR	1 OF 1