

**TOP VIEW**

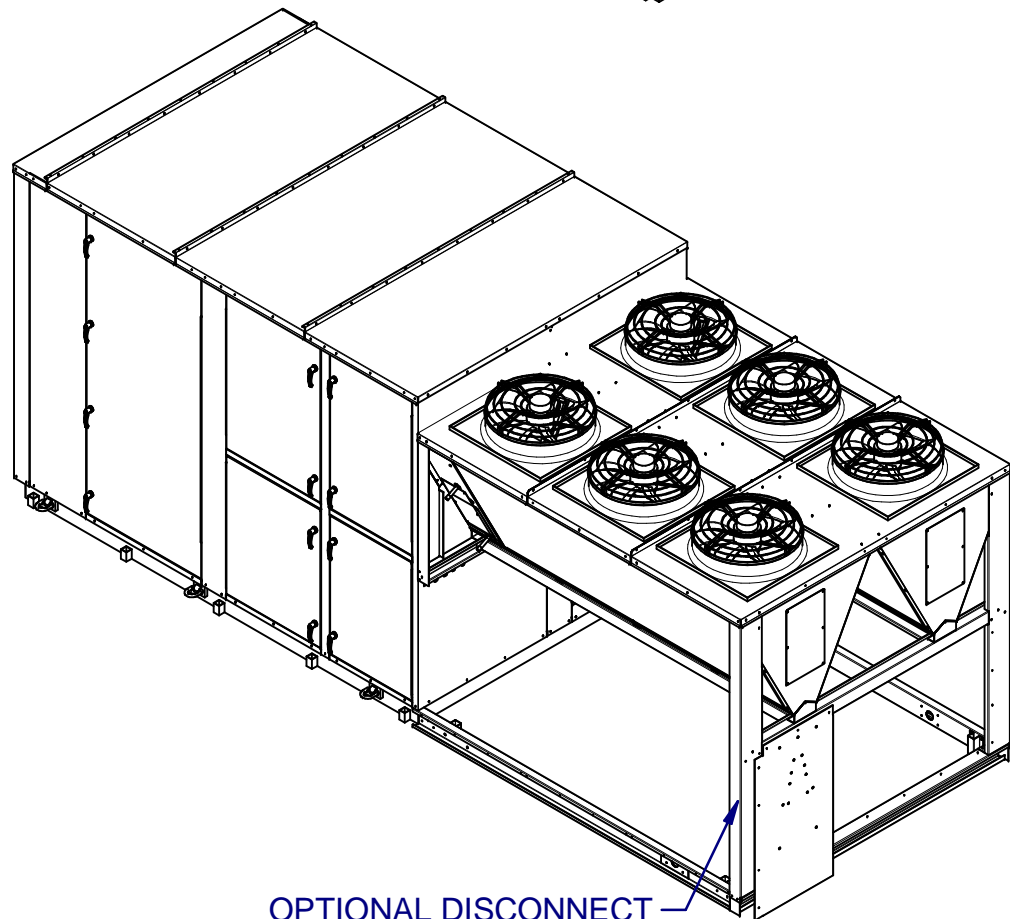

OPTIONAL DISCONNECT LOCATION

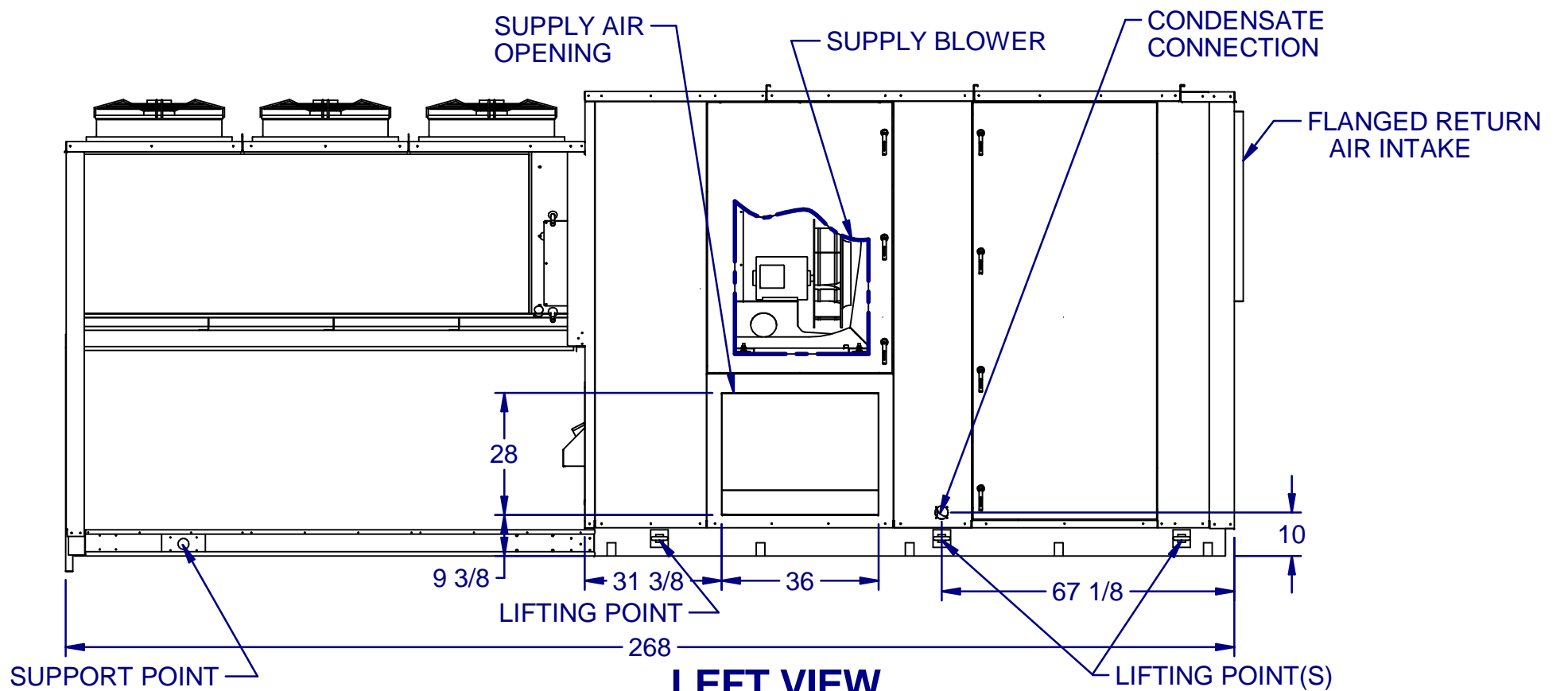

**LEFT VIEW**

COND. CONN.	GAS COND. CONN.	GAS INLET CONN.	CWC CONN.	HWC CONN.
1' 1/4" Ø FPT	1/2" Ø FPT	300-600 MBH - 3/4-1" Ø NPT	3 1/8" Ø	3 1/8" Ø

DRAWING NUMBER: 07951-5035-1 4/23/2021

TITLE: PR E8 SS END RTRN NO EXH CAB 1 OF 1