

100% OUTSIDE AIR WITH BAROMETRIC RELIEF

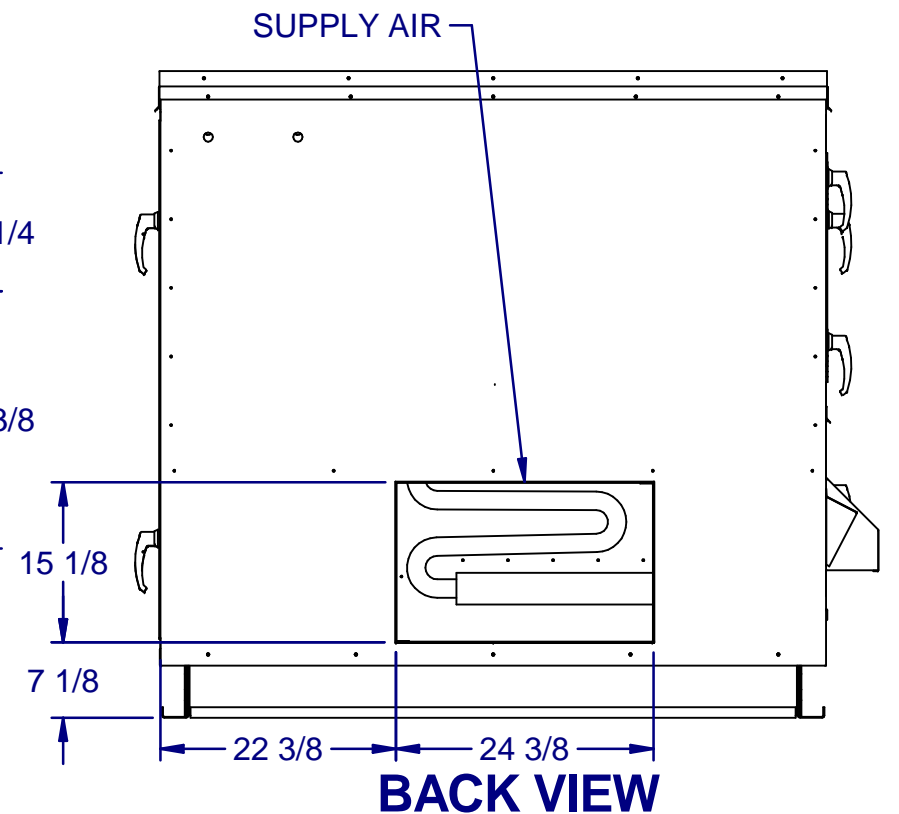
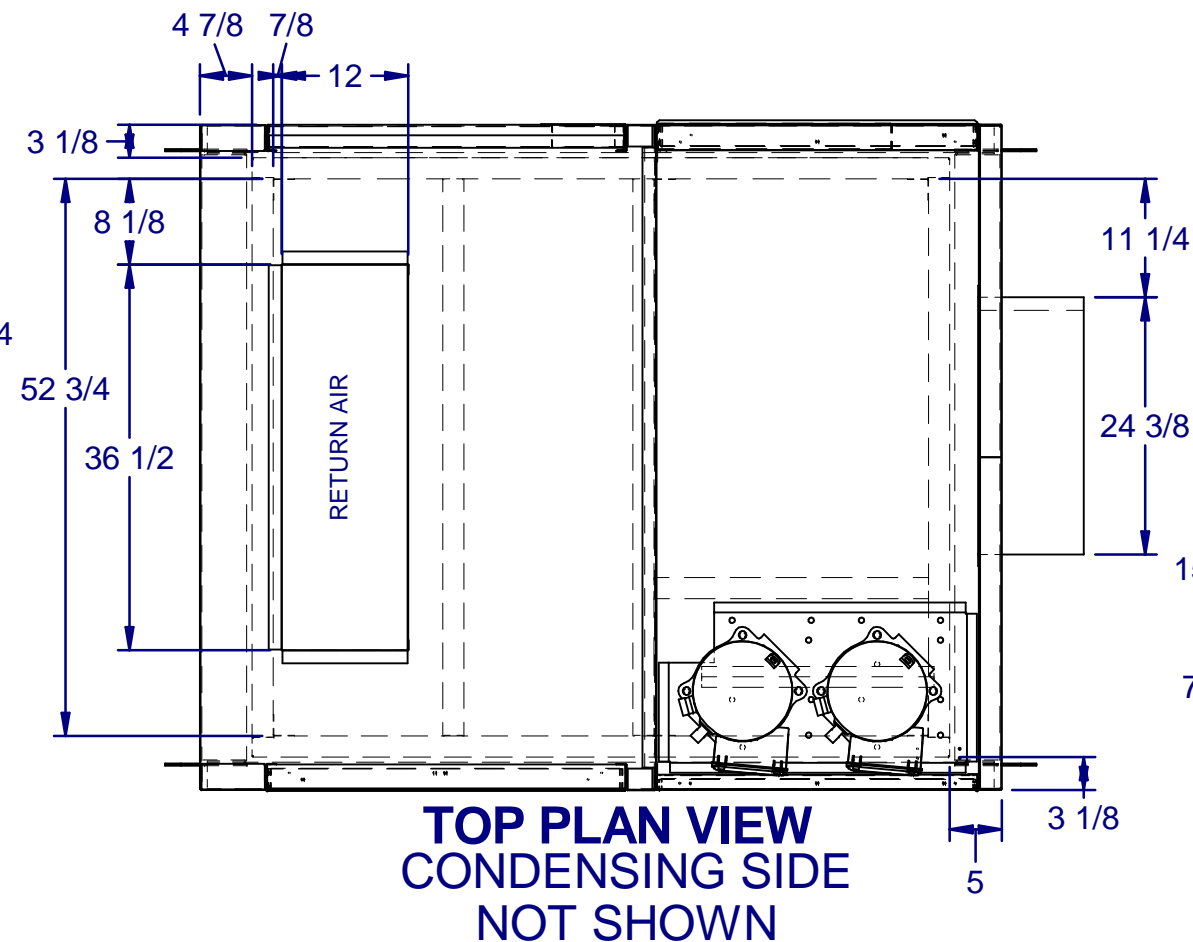
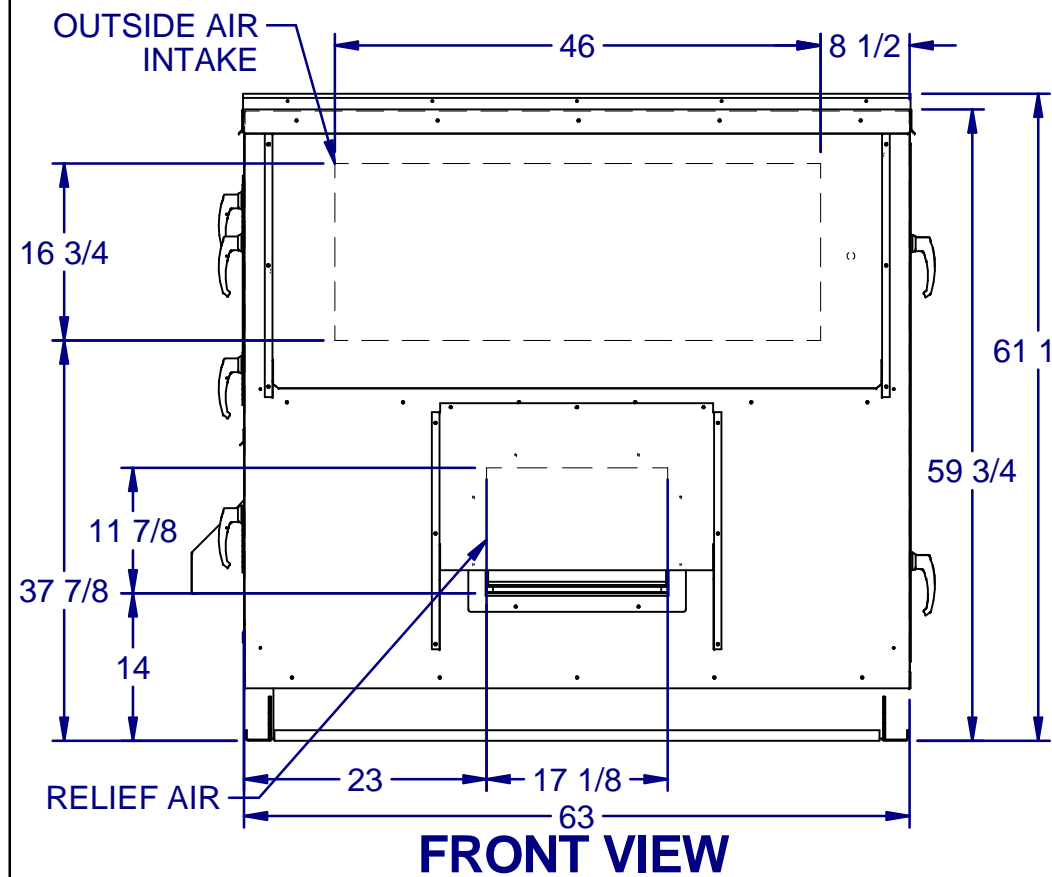
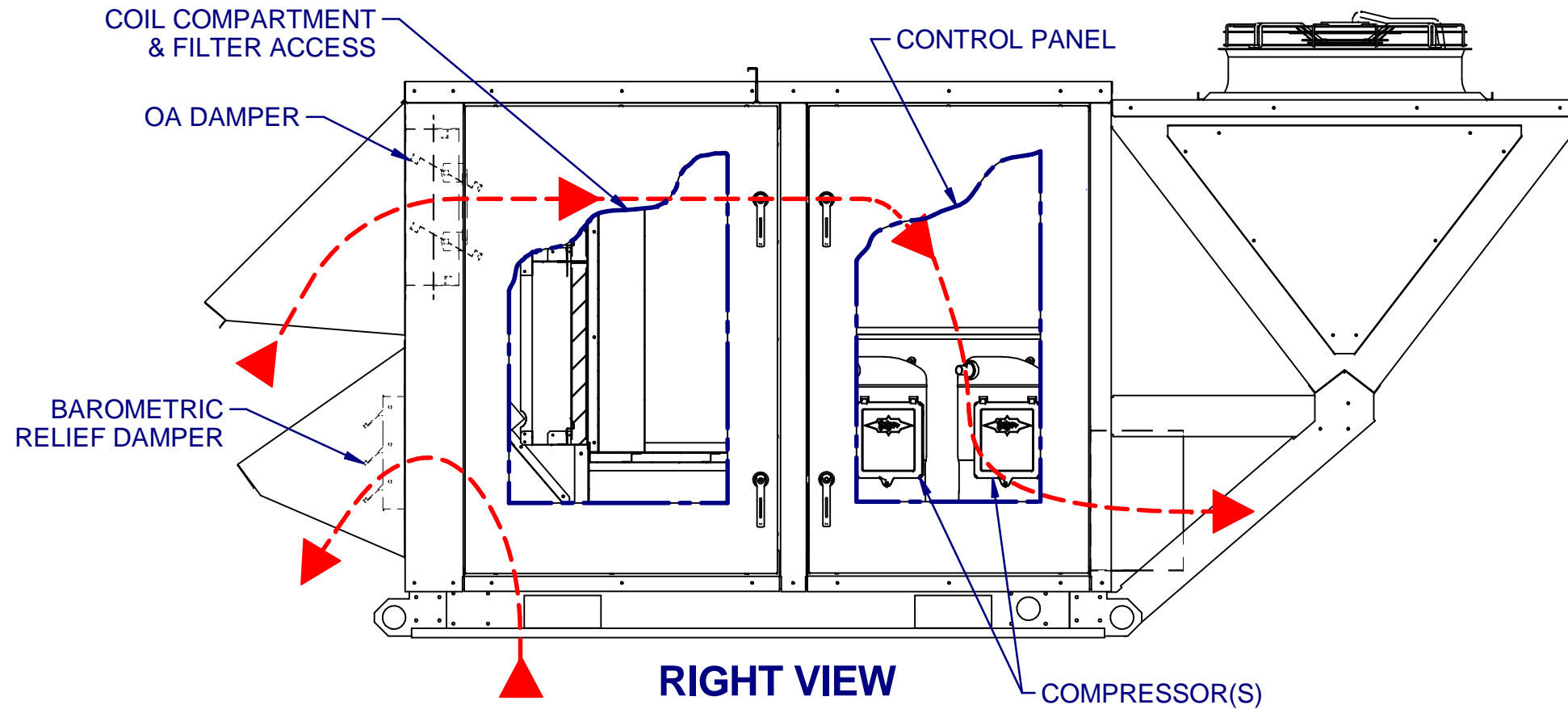

DRAWING NUMBER: 05041-2504-2	12/21/2015
TITLE: PR B2 CAB NO EXH HOR	1 OF 1