

100% OUTSIDE AIR WITH RECIRCULATING OPTION OR MIXED AIR

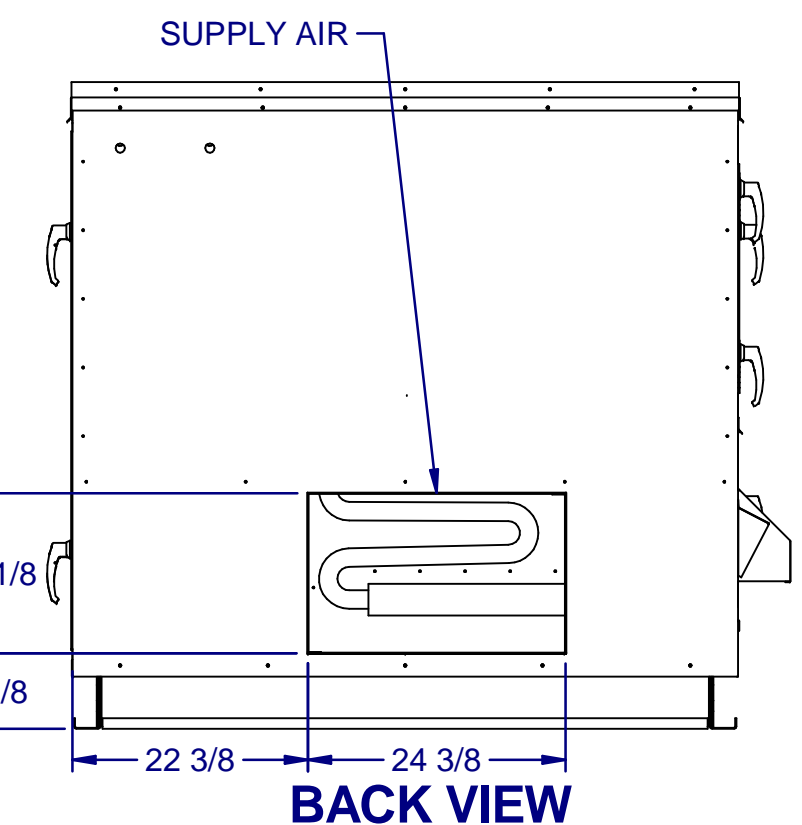
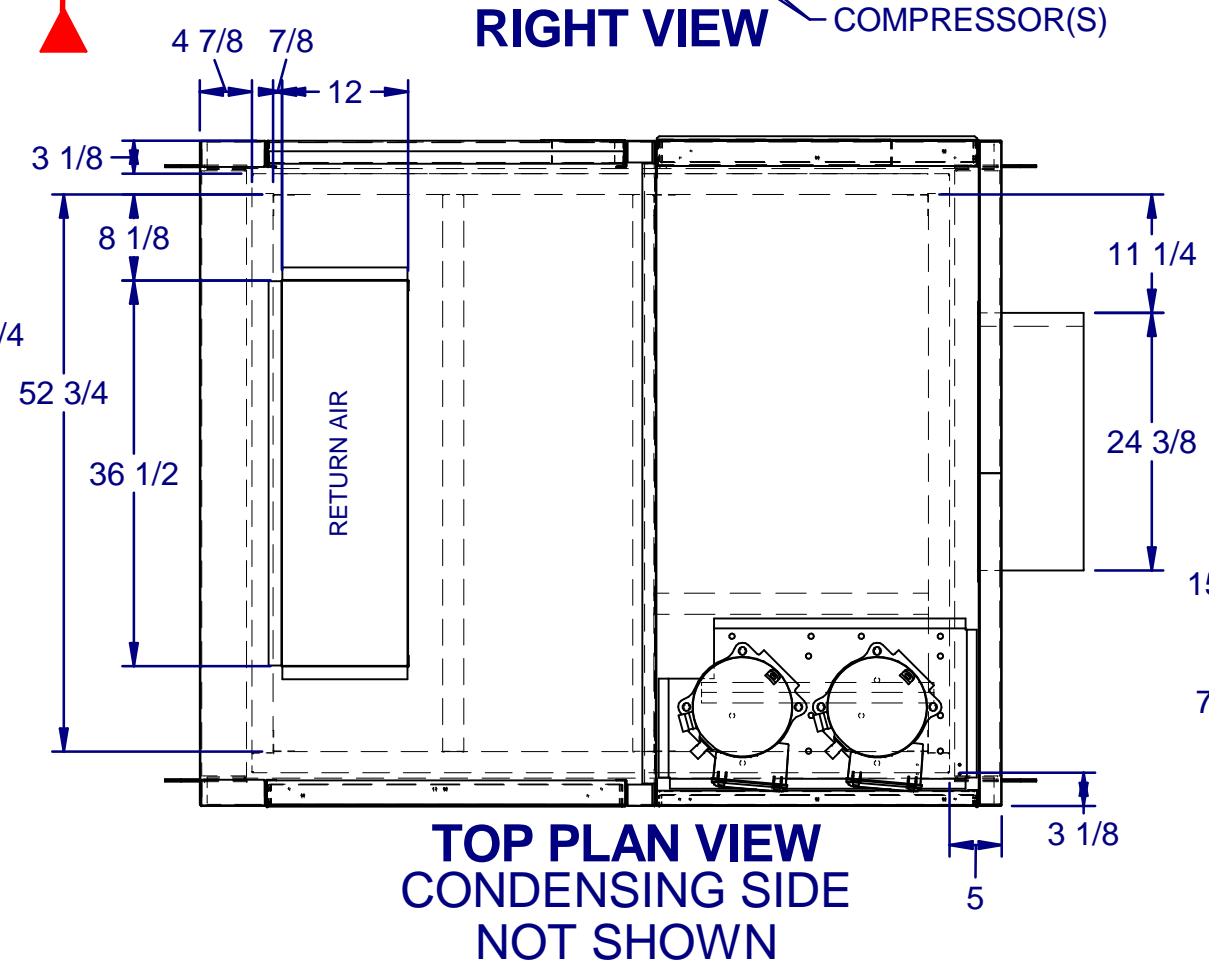
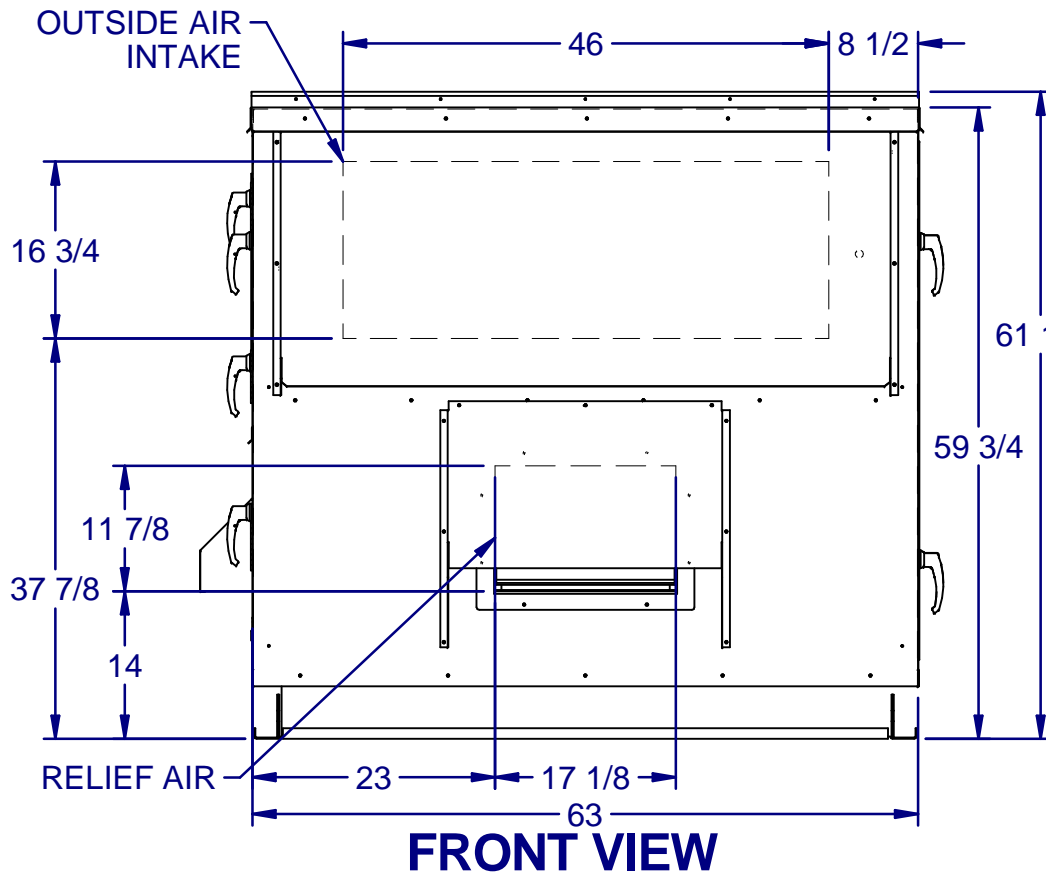
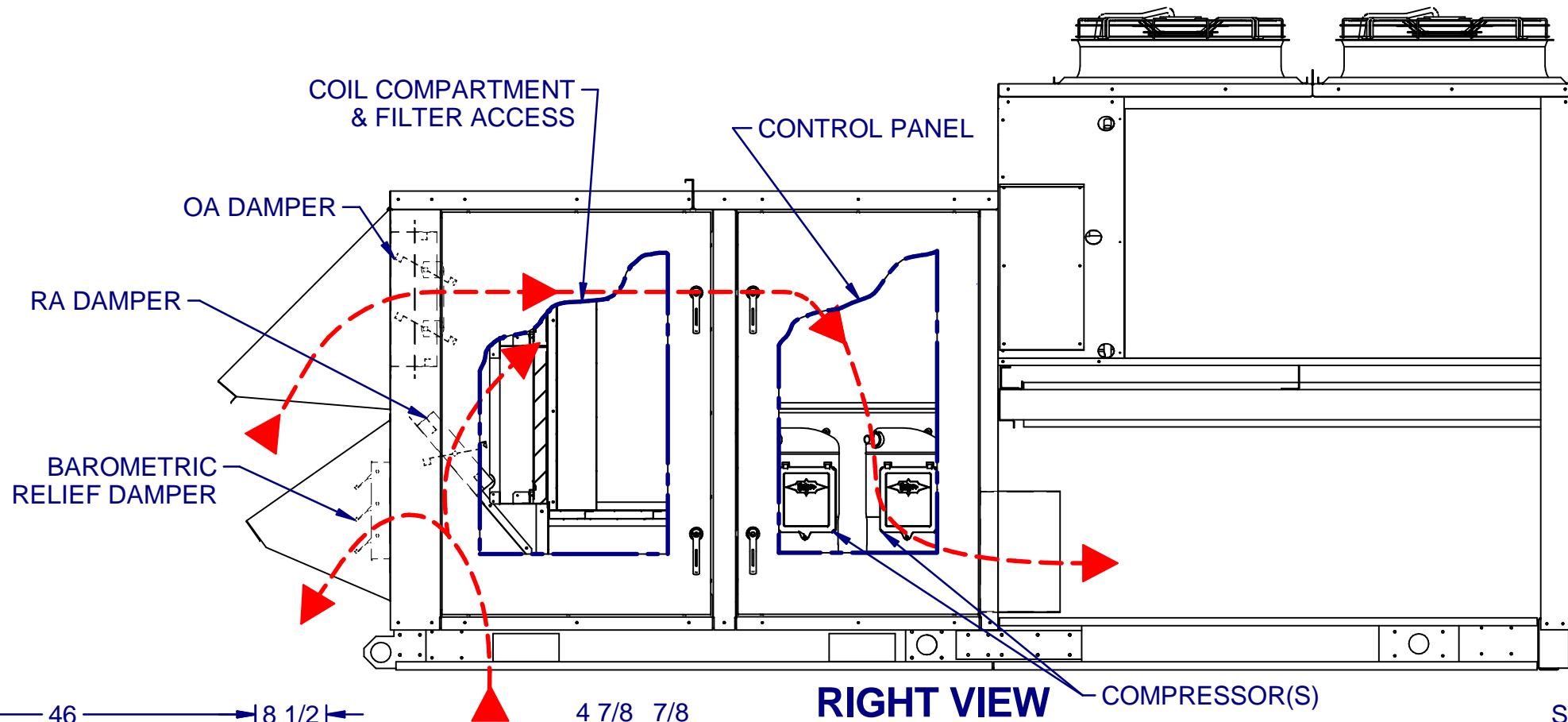

DRAWING NUMBER: 0504I-2506-3	12/21/2015
TITLE: PR B4 CAB NO EXH HOR	1 OF 1