

100% OUTSIDE AIR

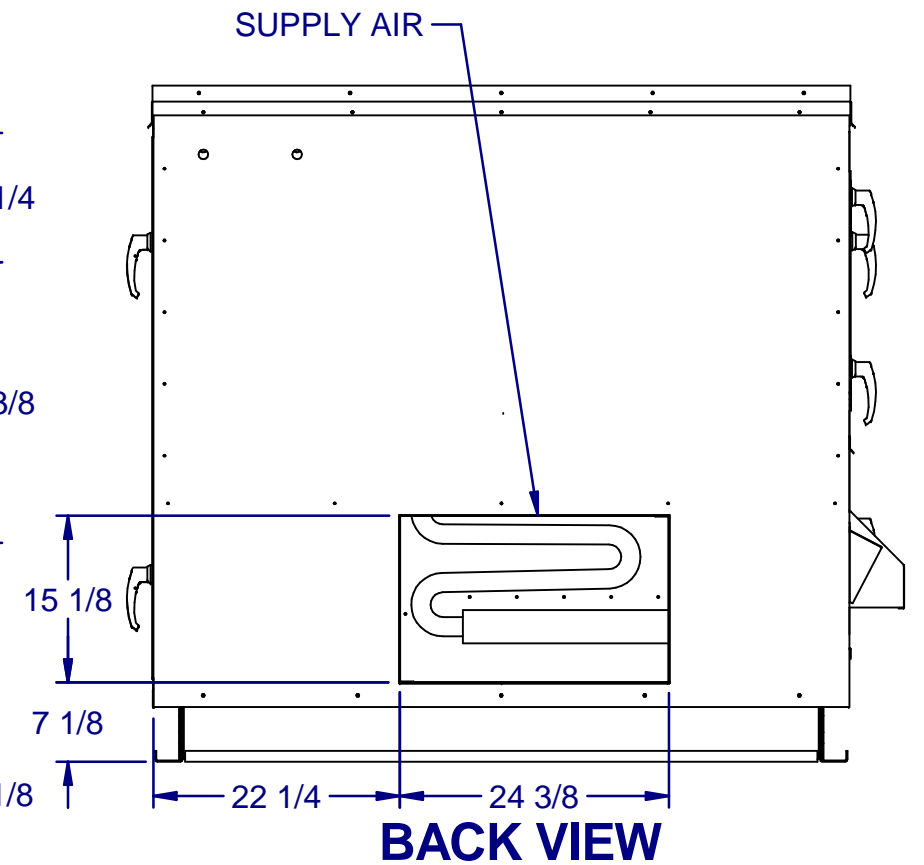
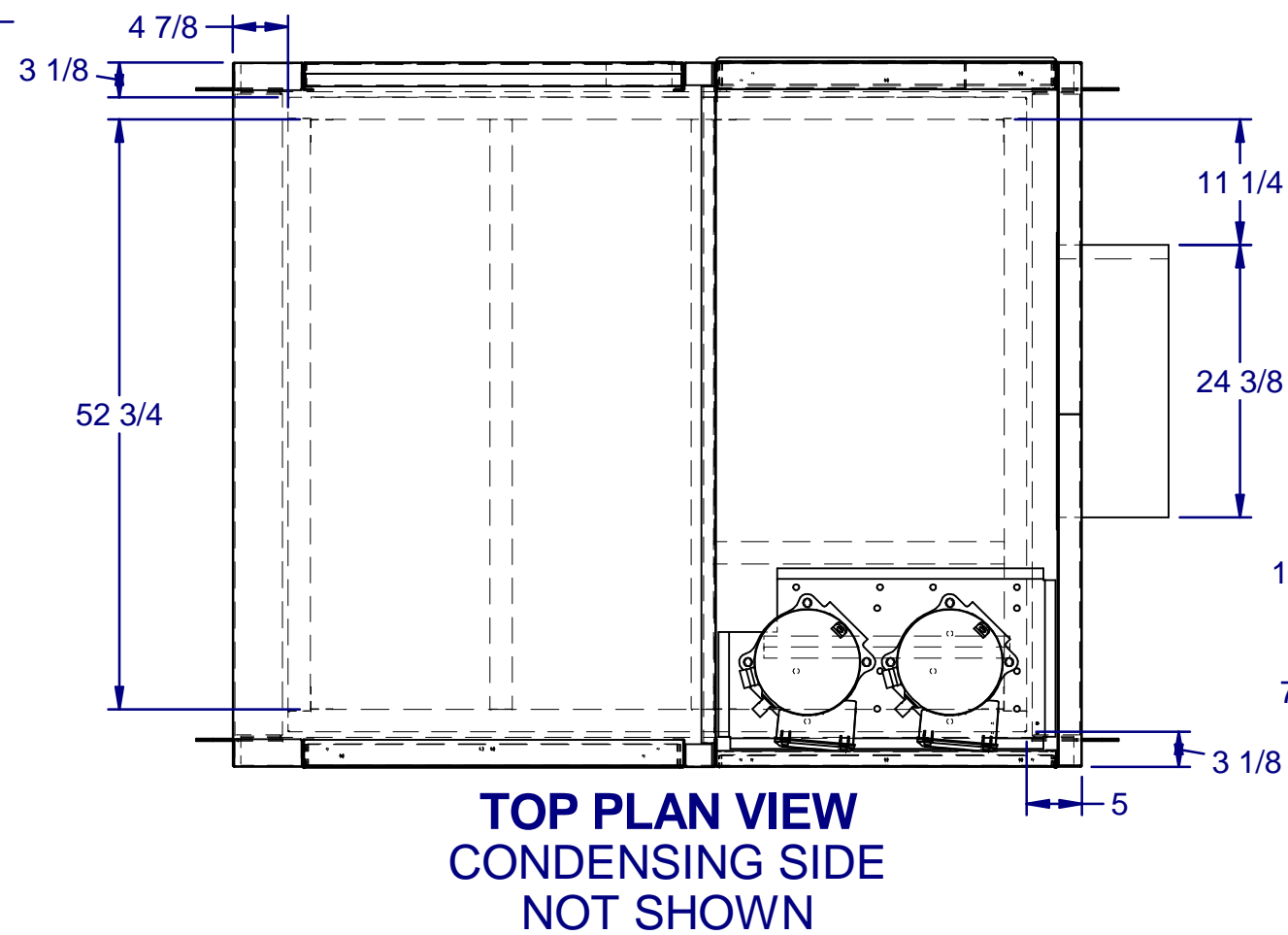
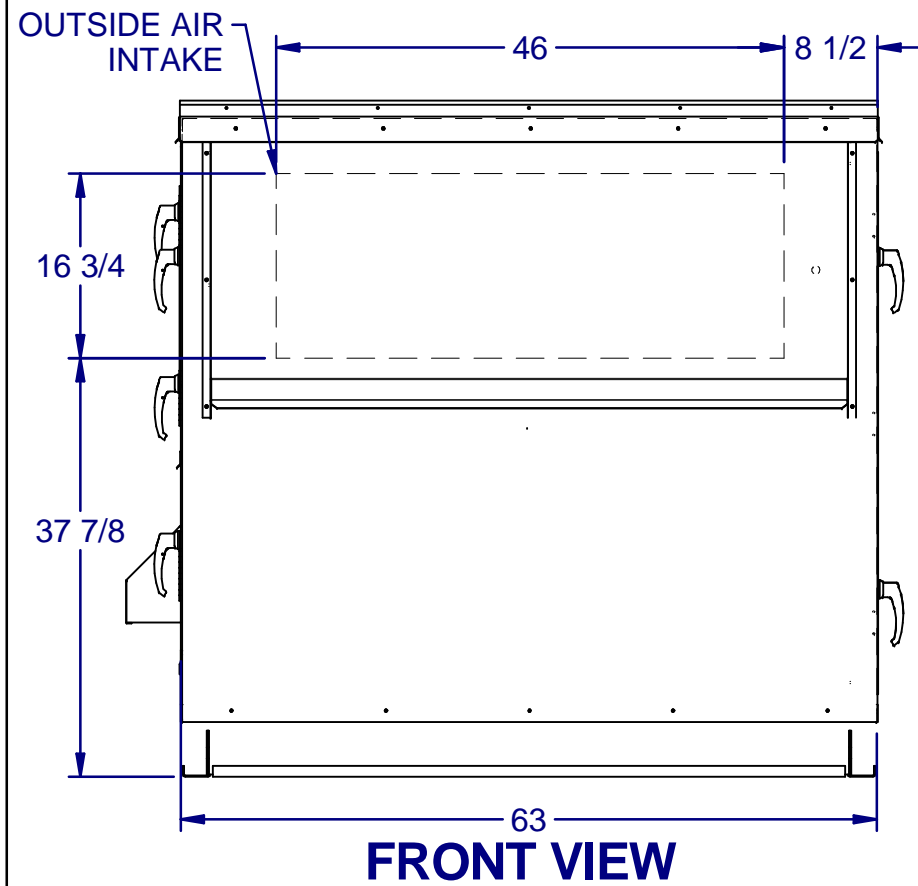
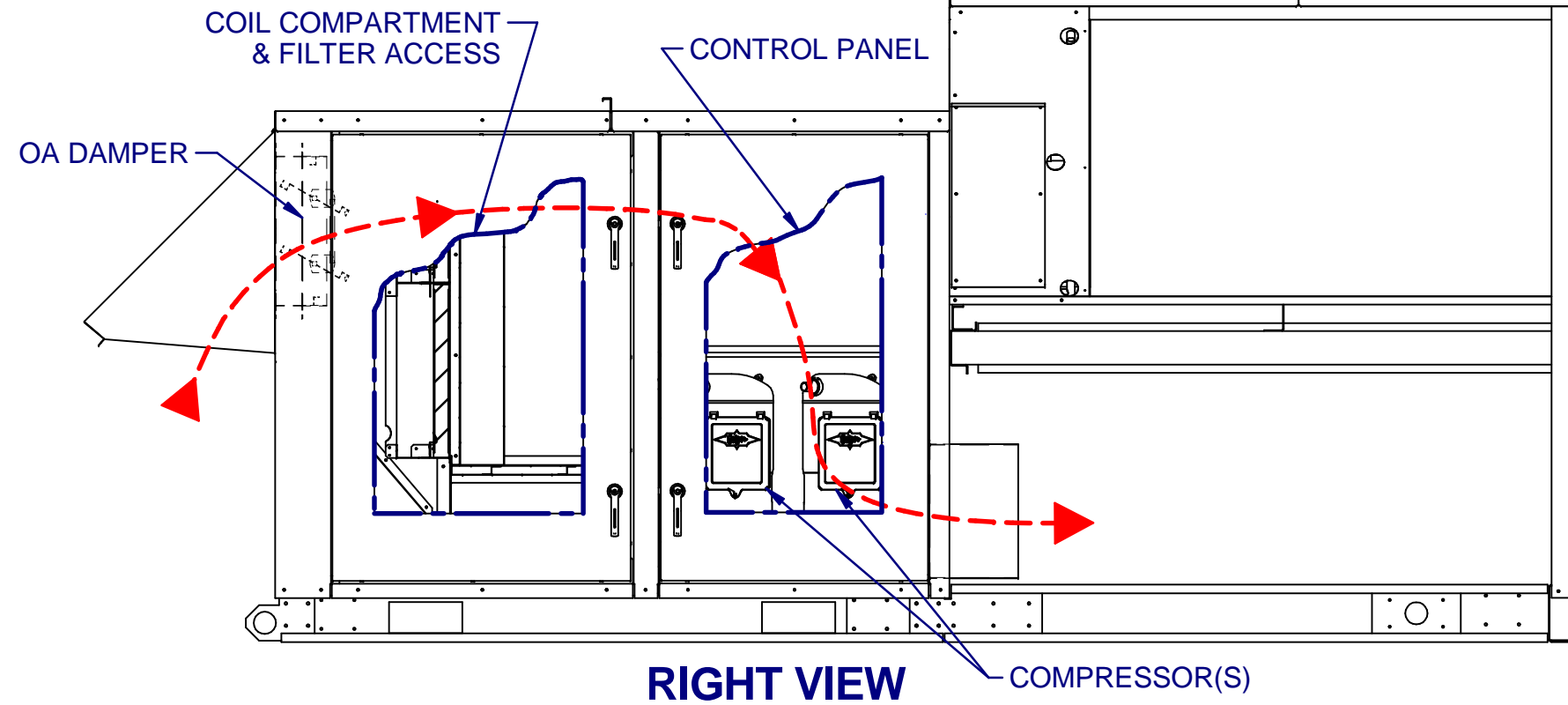

DRAWING NUMBER: 0504I-2506-4	12/21/2015
TITLE: PR B4 CAB NO EXH HOR	1 OF 1