

DRAWING NUMBER: 05041-2511	12/21/2015
TITLE: PR B1XL CAB	1 OF 2

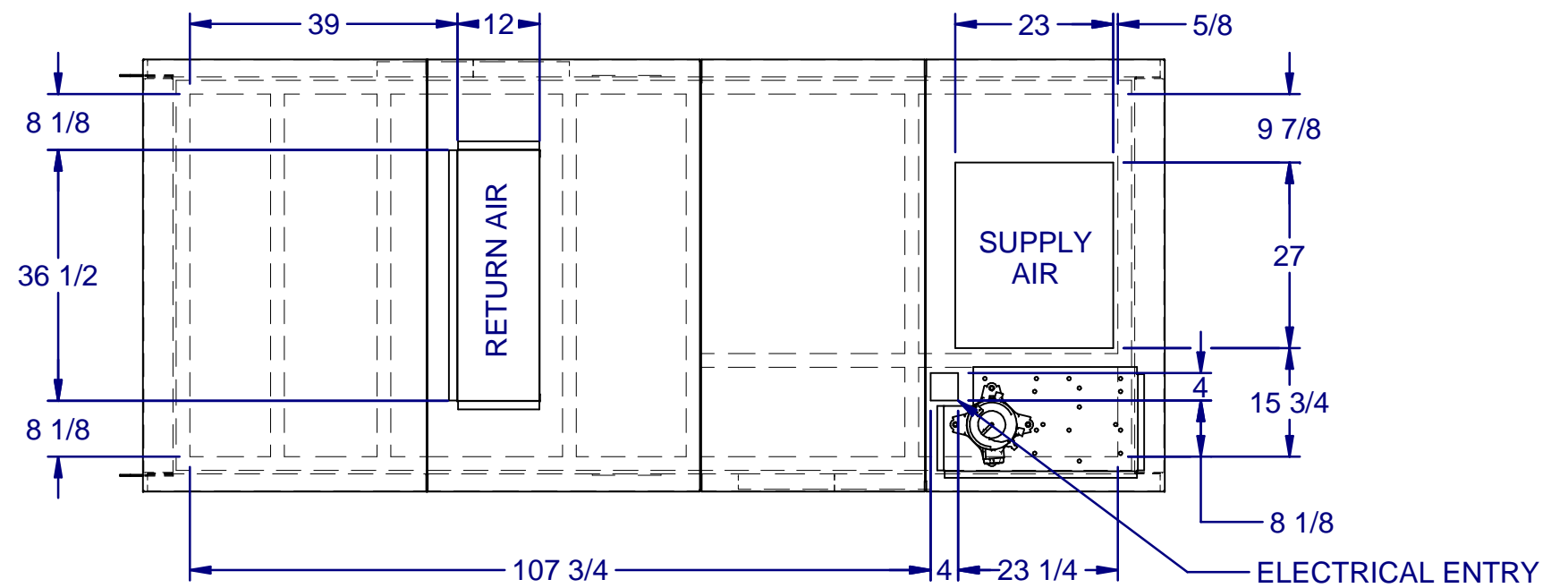
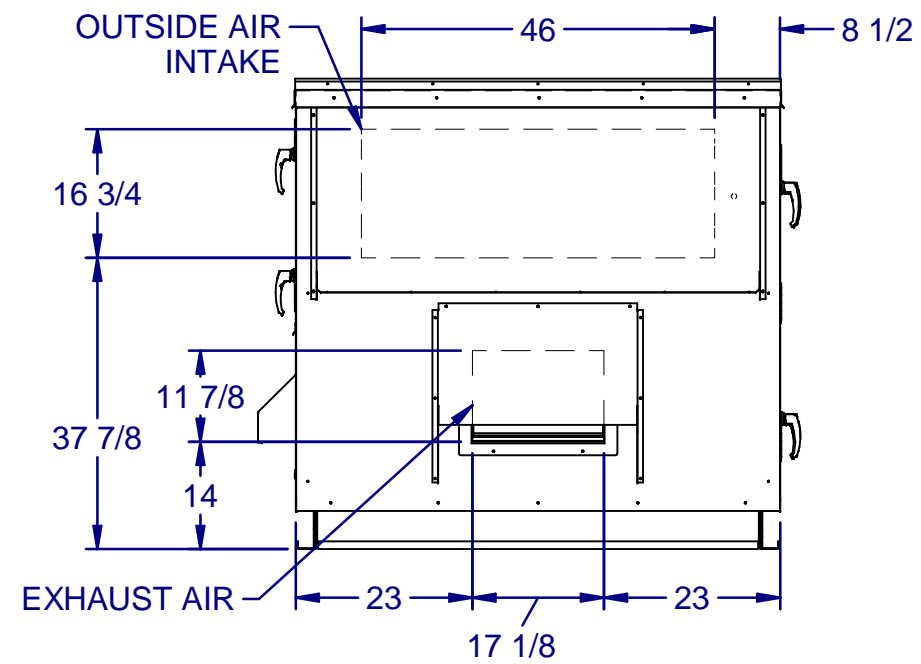
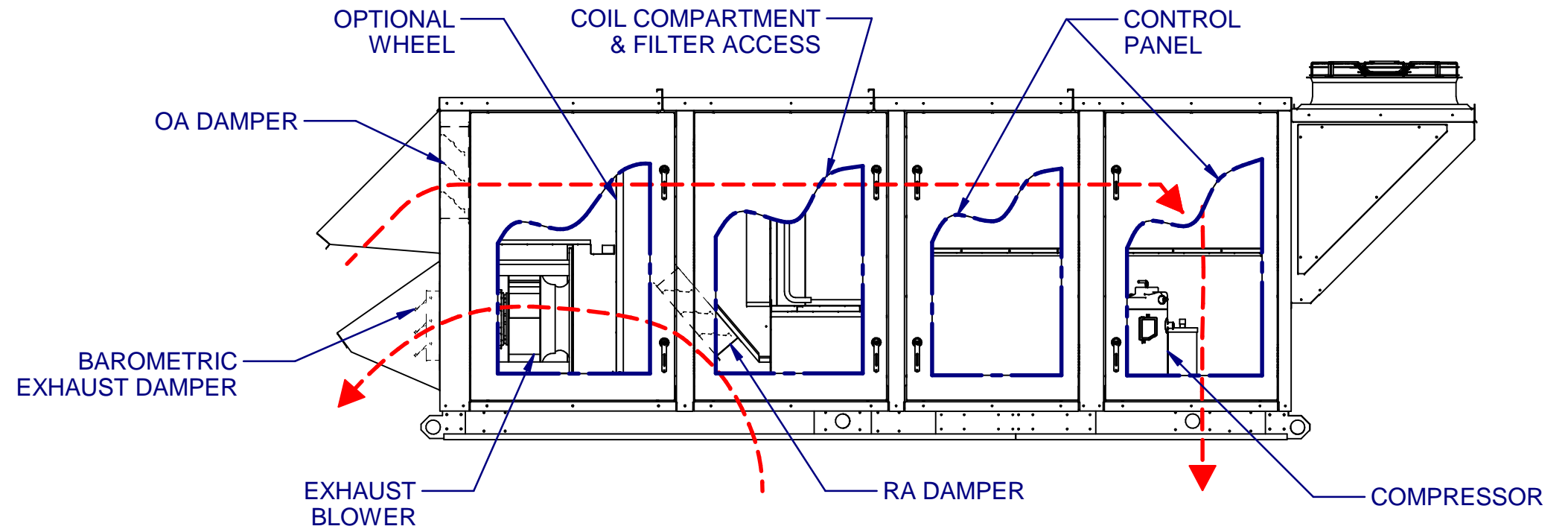

TOP PLAN VIEW  
CONDENSING SIDE  
NOT SHOWN

DRAWING NUMBER: 05041-2511	12/21/2015
TITLE: PR B1XL CAB	2 OF 2