

DRAWING NUMBER: 05041-2513	12/21/2015
TITLE: PR B2XL CAB	1 OF 2

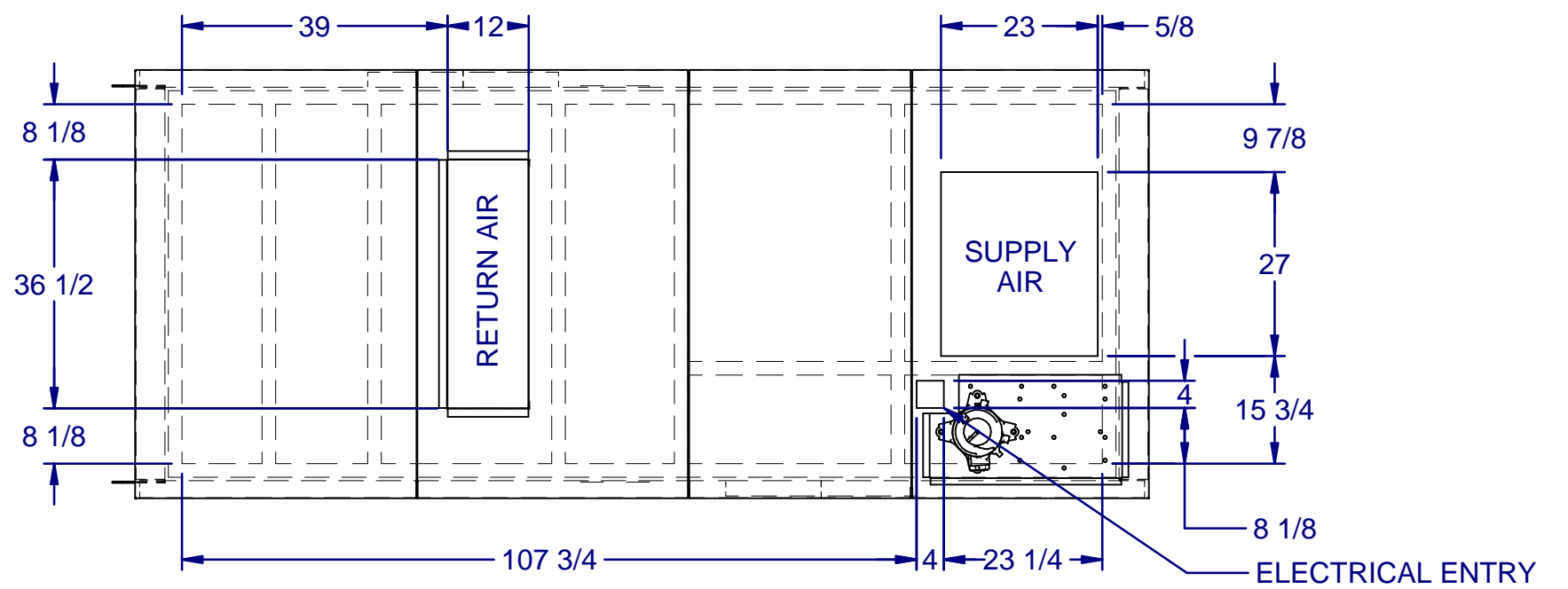
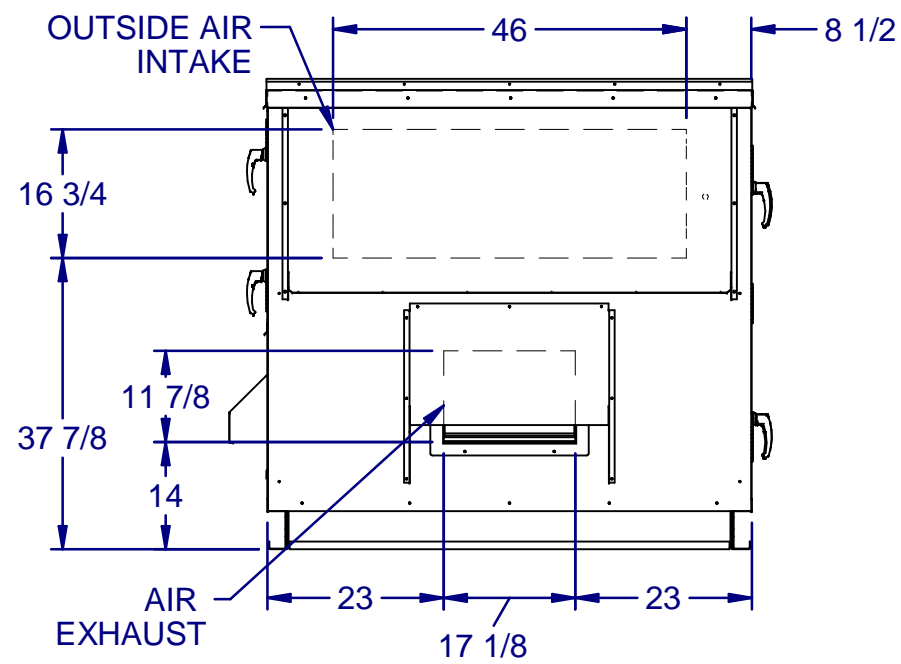
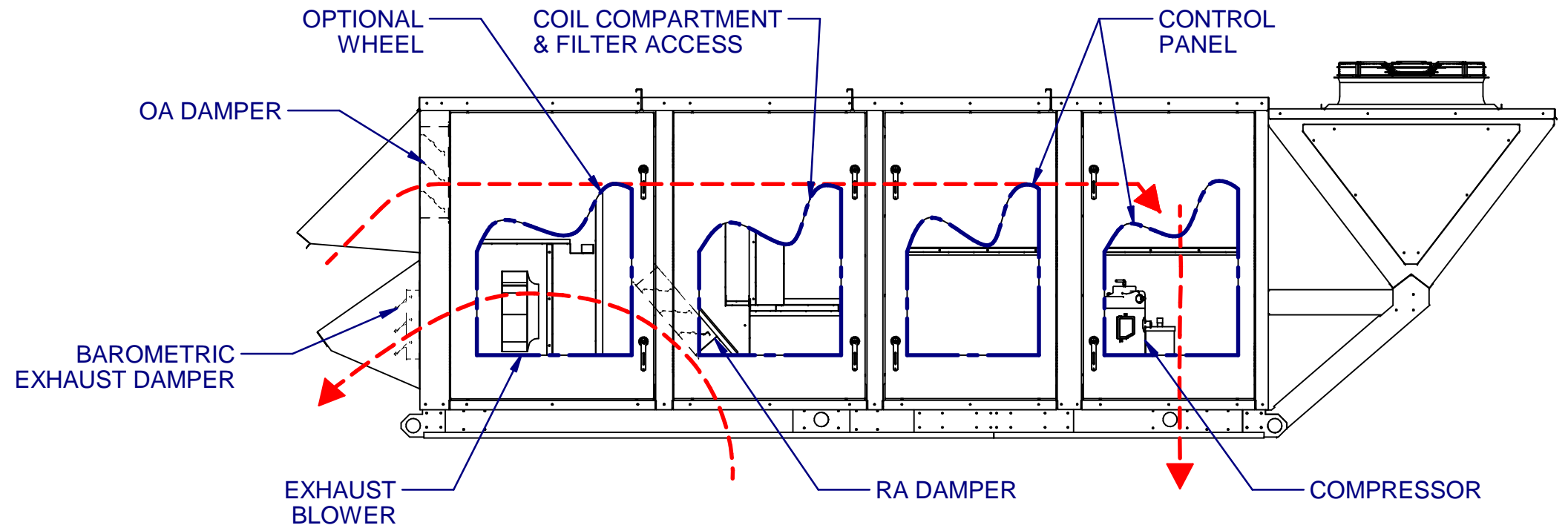

TOP PLAN VIEW
 CONDENSING SIDE
 NOT SHOWN

DRAWING NUMBER: 05041-2513	12/21/2015
TITLE: PR B2XL CAB	2 OF 2