

100% OUTSIDE AIR

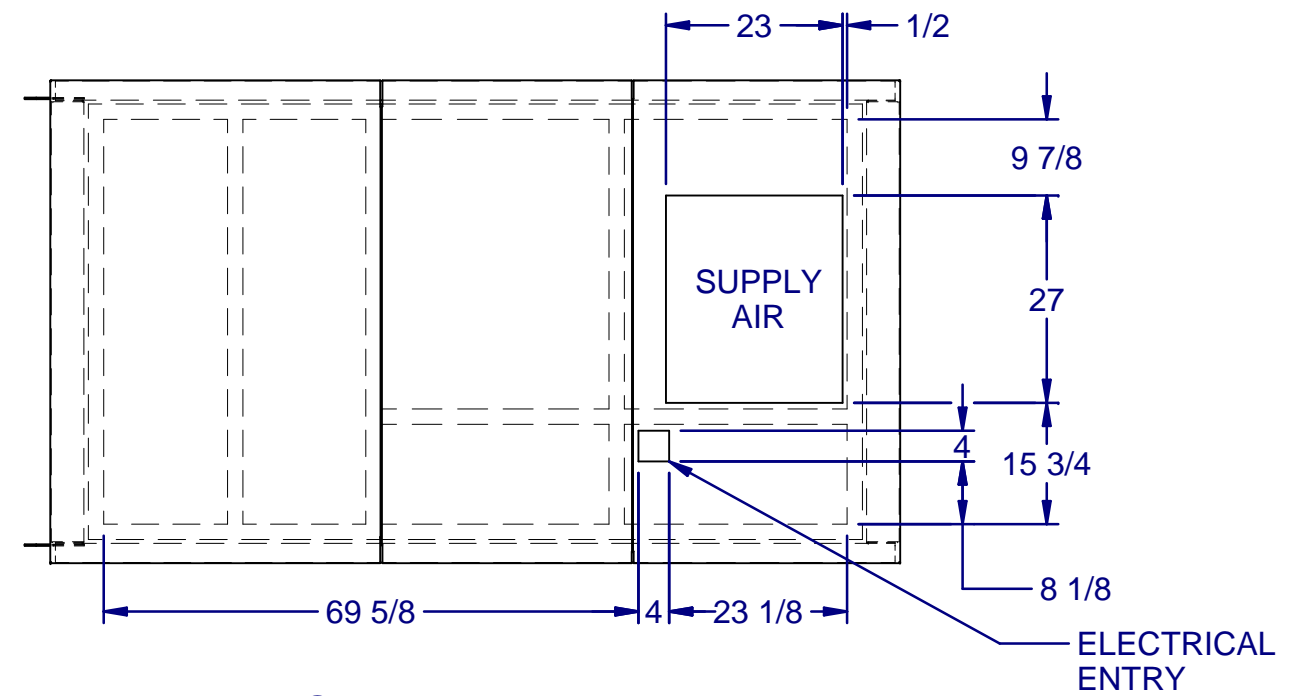
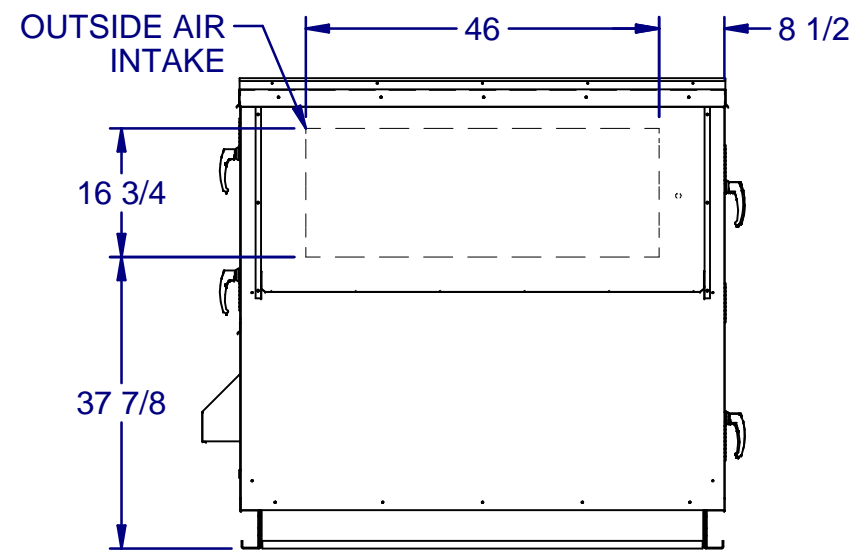
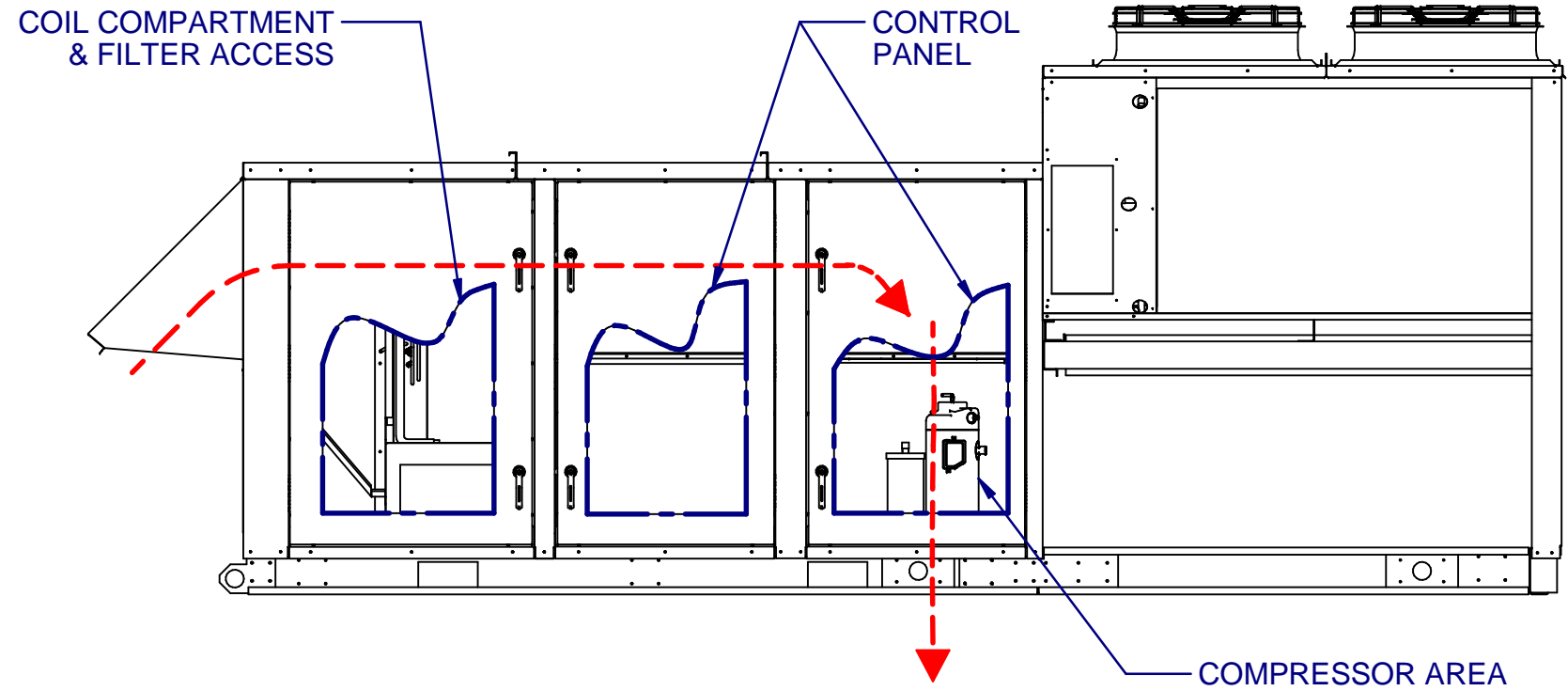

TOP PLAN VIEW
CONDENSING SIDE
NOT SHOWN

DRAWING NUMBER: 05041-2516-4	12/21/2015
TITLE: PR B4XL CAB NO EXH	1 OF 1