

100% OUTSIDE AIR WITH BAROMETRIC RELIEF

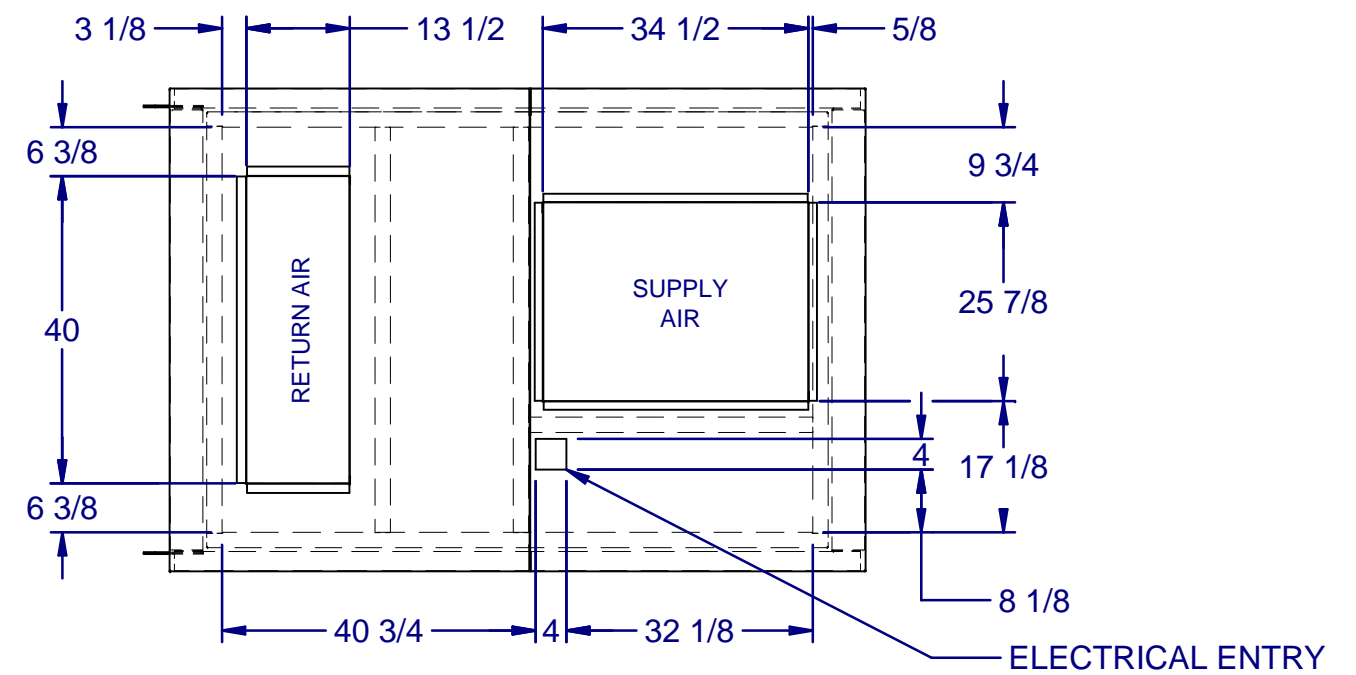
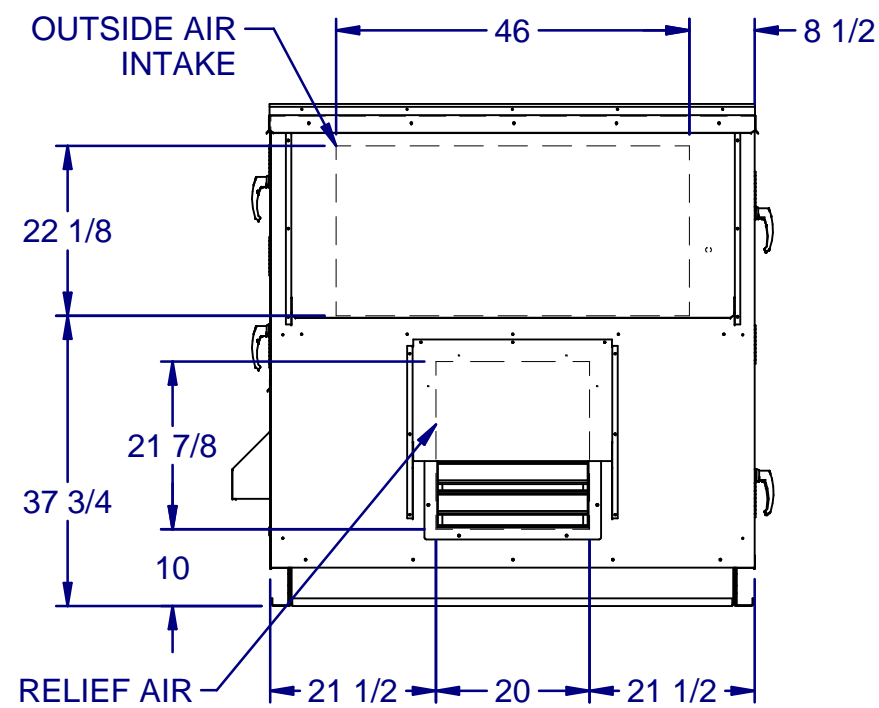
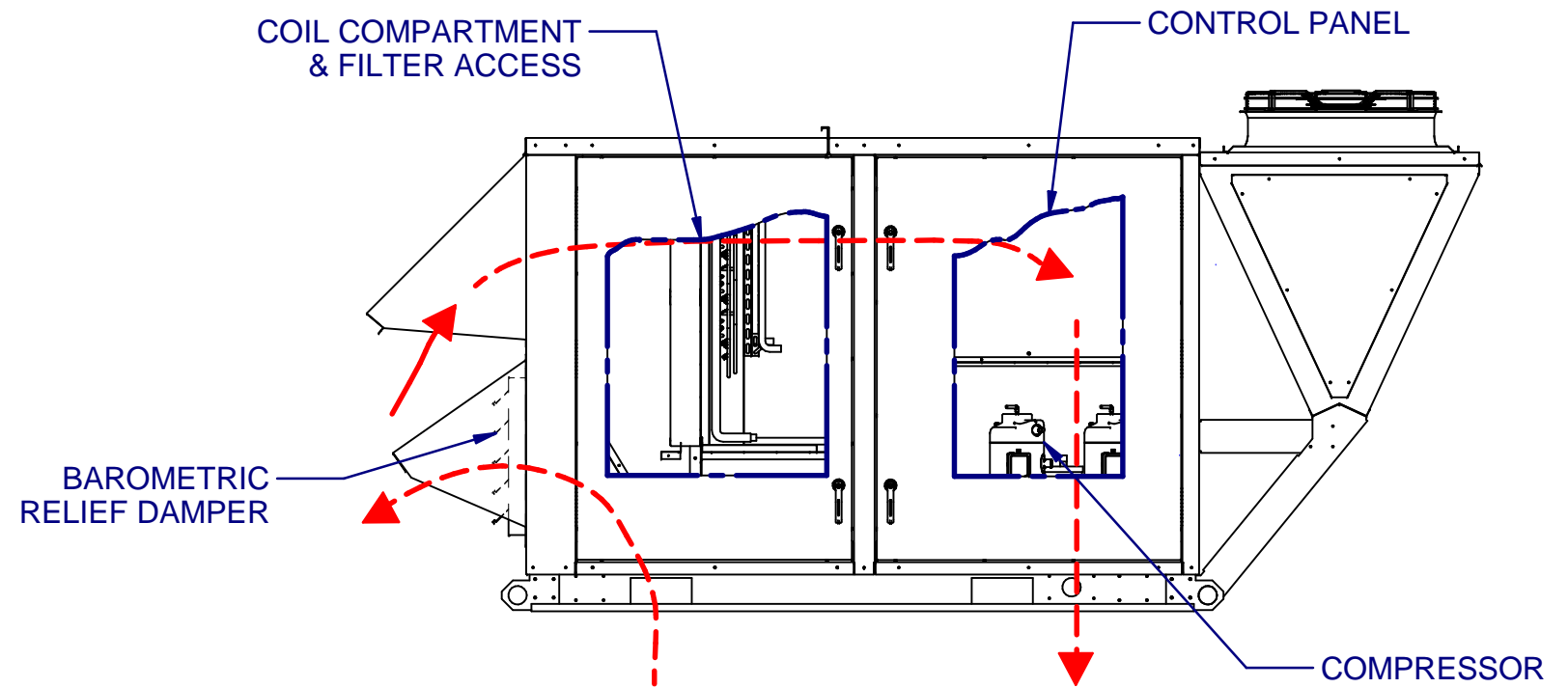

**TOP PLAN VIEW
CONDENSING SIDE
NOT SHOWN**

DRAWING NUMBER: 05041-2532-2	12/21/2015
TITLE: PR C2 CAB NO EXH	1 OF 1