

# 100% OUTSIDE AIR WITH RECIRCULATING OPTION OR MIXED AIR

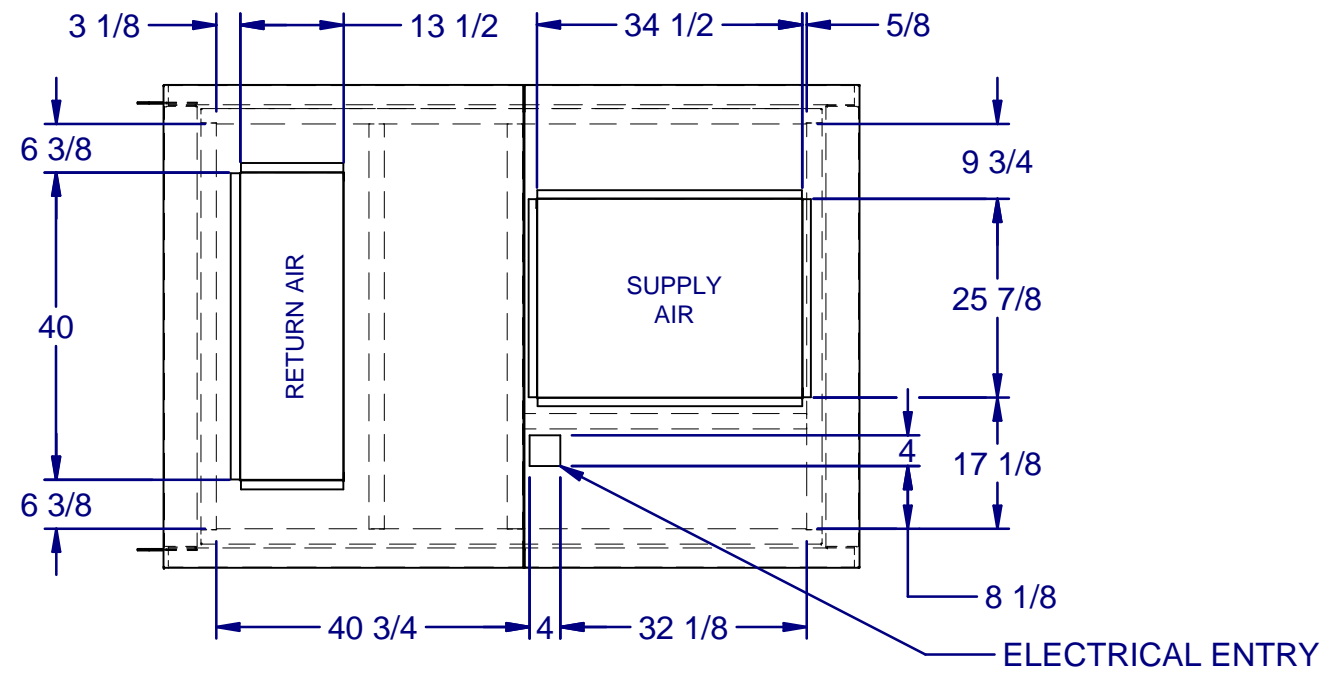
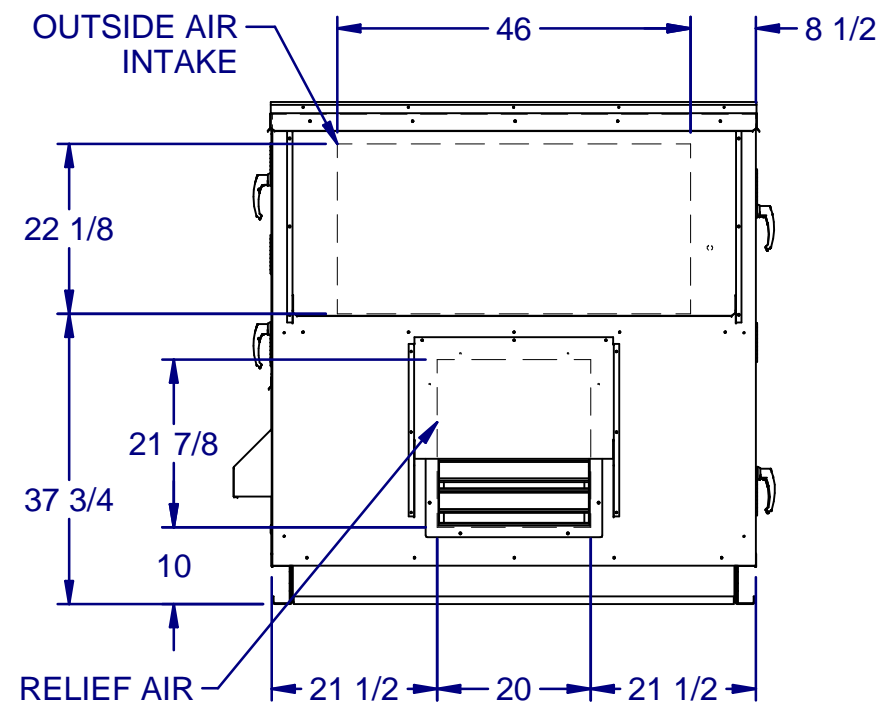
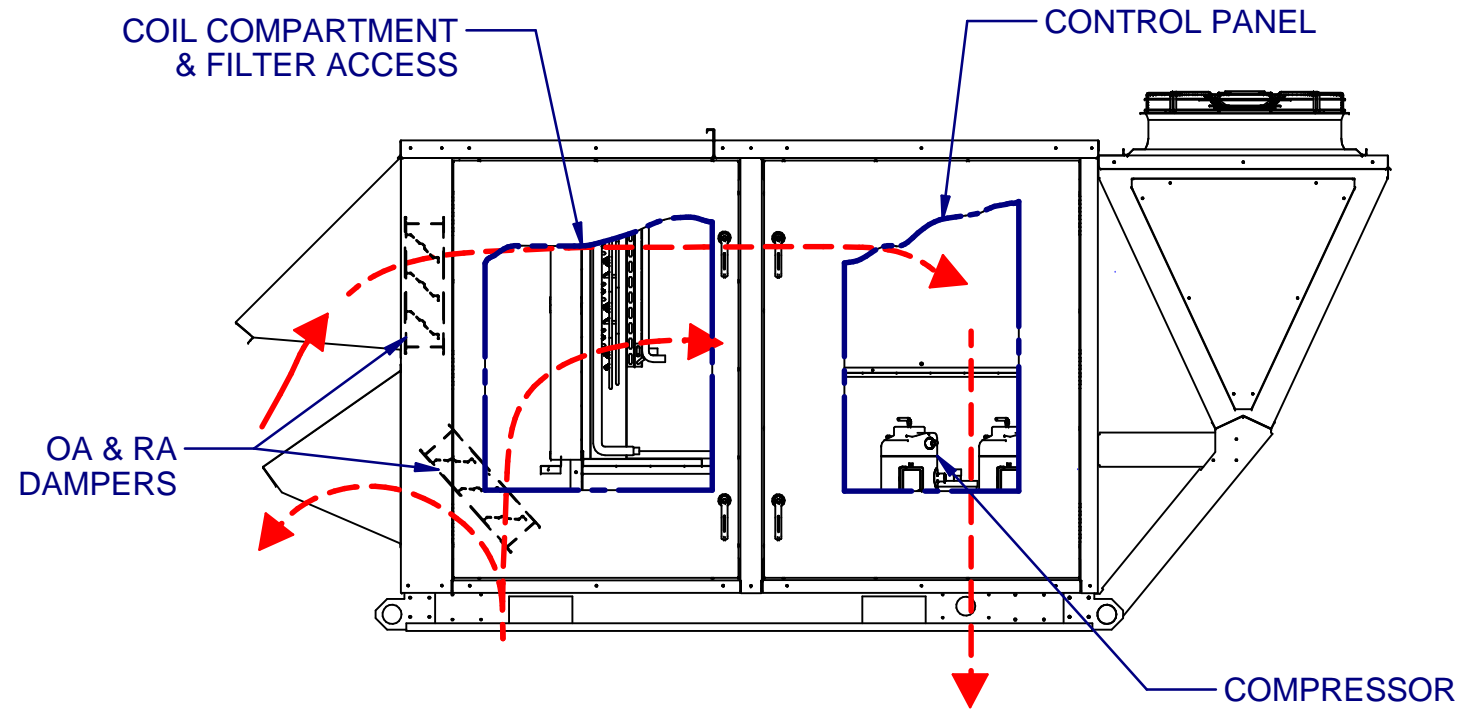

**TOP PLAN VIEW  
CONDENSING SIDE  
NOT SHOWN**

DRAWING NUMBER: 05041-2532-3	12/21/2015
TITLE: PR C2 CAB NO EXH	1 OF 1