

100% OUTSIDE AIR

COIL COMPARTMENT & FILTER ACCESS

CONTROL PANEL

OA HOOD

COMPRESSOR(S)

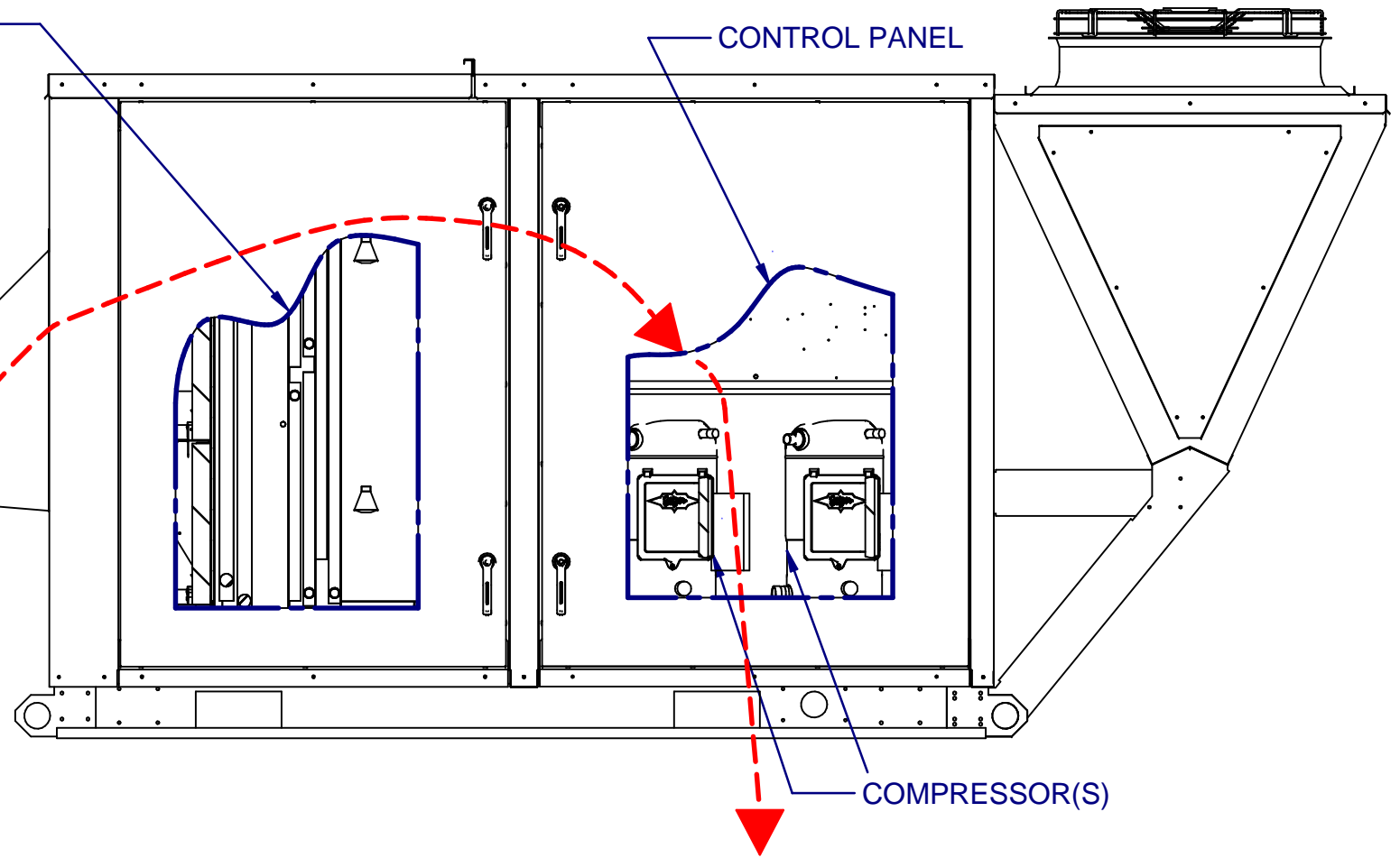

OUTSIDE AIR INTAKE

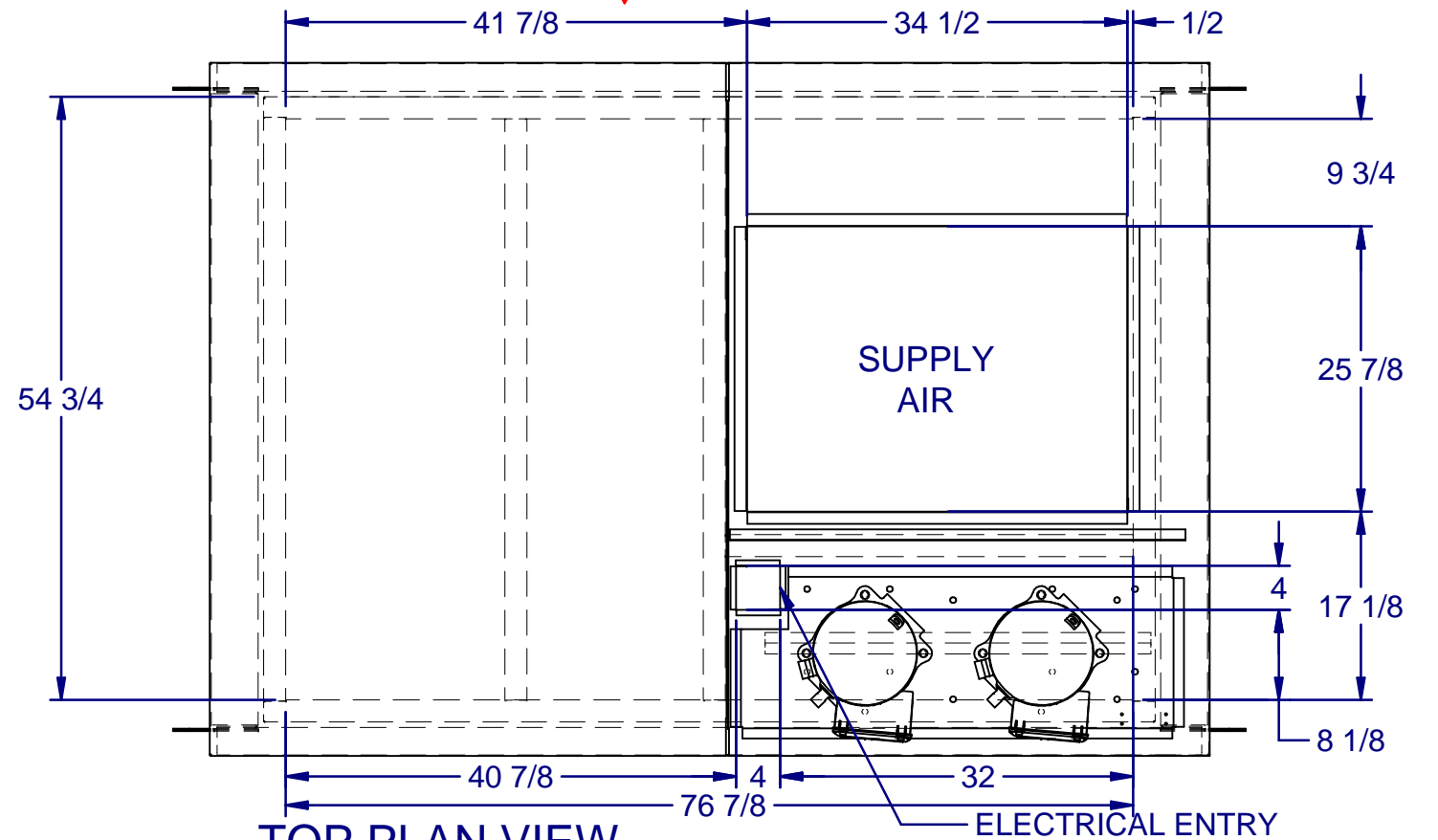
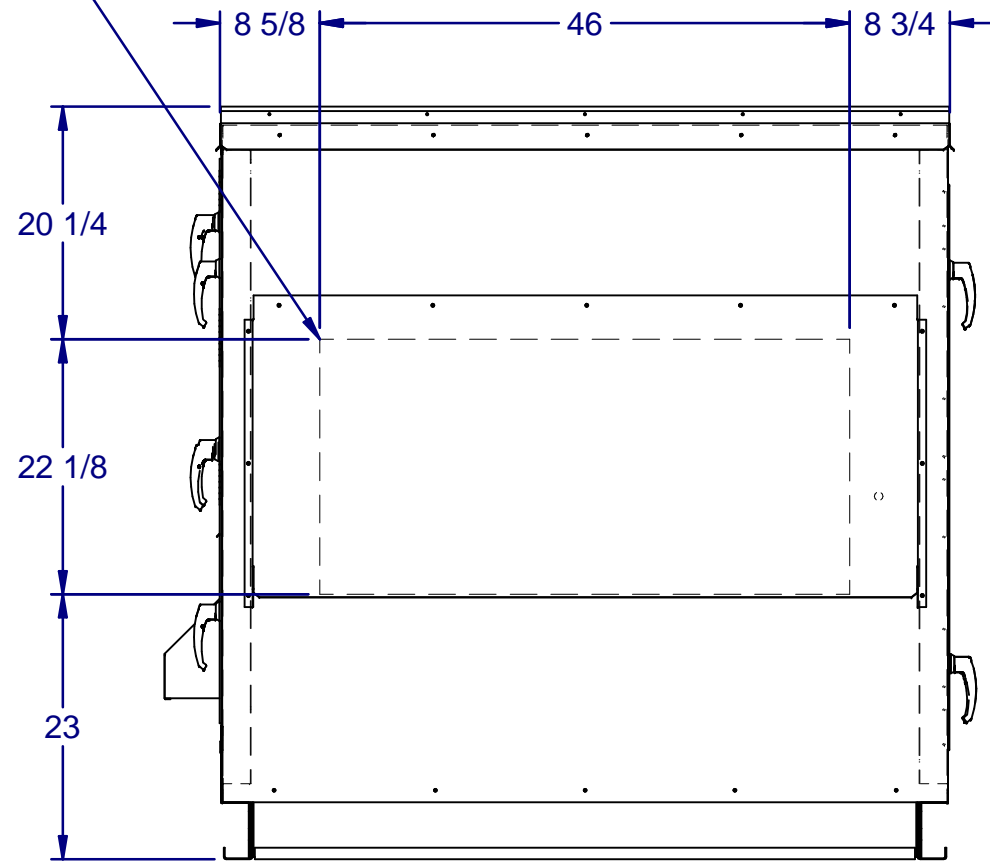

TOP PLAN VIEW
CONDENSING SIDE
NOT SHOWN

DRAWING NUMBER: 05041-2532-4	12/21/2015
TITLE: PR C2 CAB NO EXH	1 OF 1