

RECIRCULATING OPTION

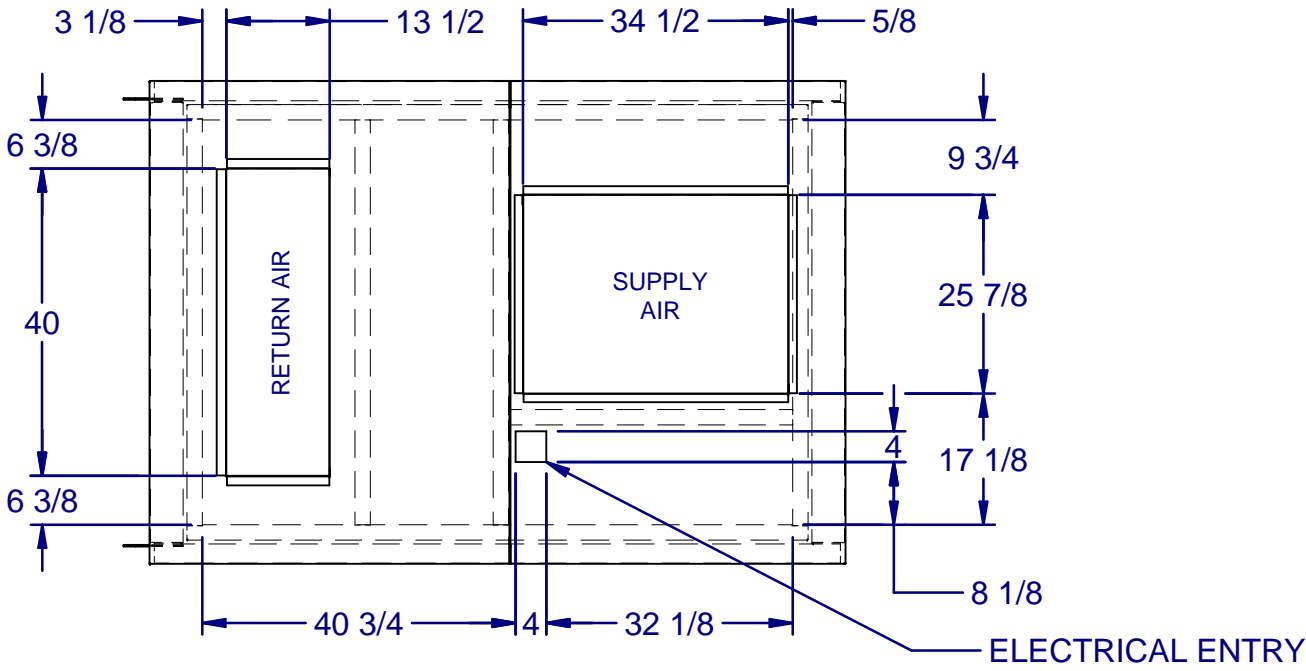
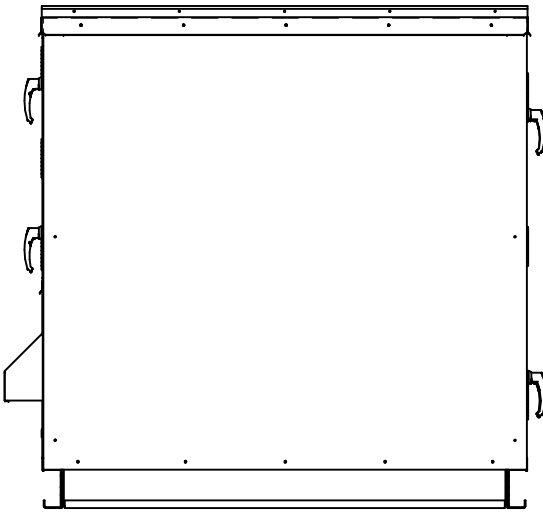
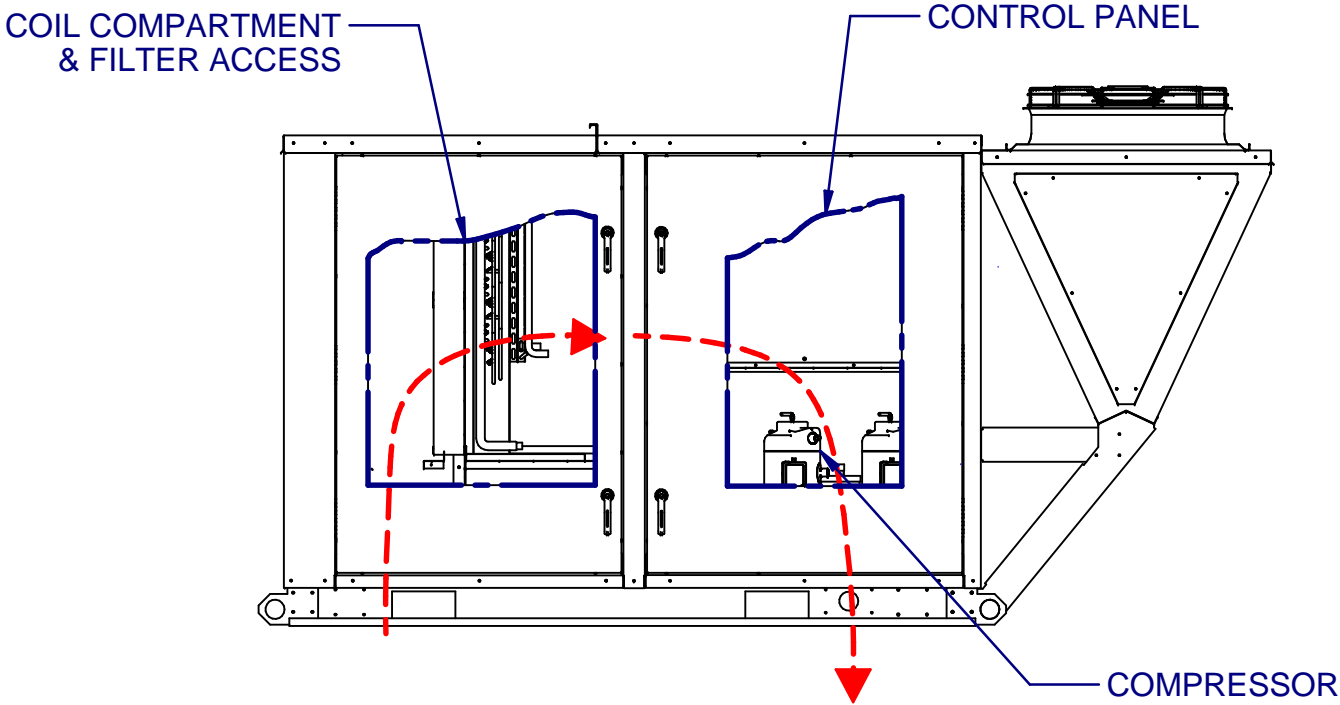

TOP PLAN VIEW
CONDENSING SIDE
NOT SHOWN

DRAWING NUMBER: 05041-2532-5	11/7/2016
TITLE: PR C2 CAB NO EXH	1 OF 1