

RECIRCULATING OPTION

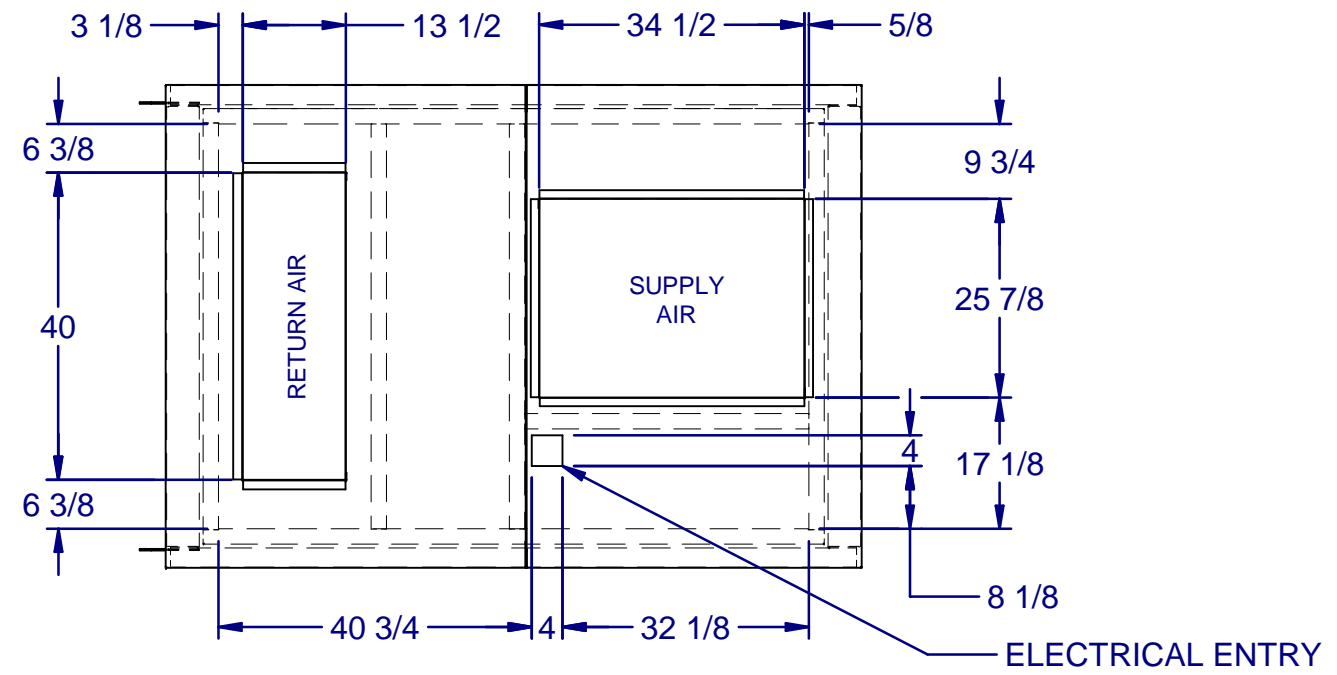
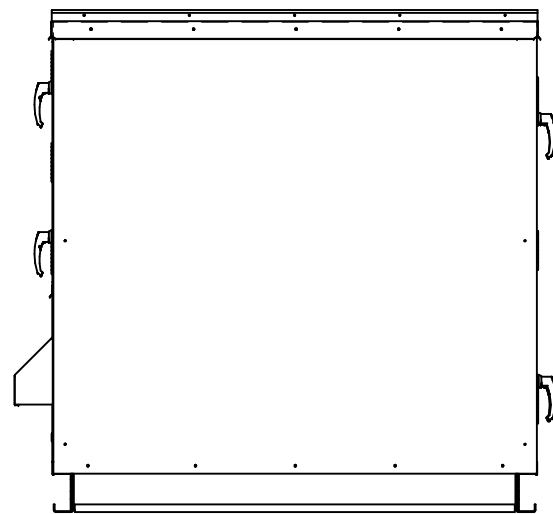
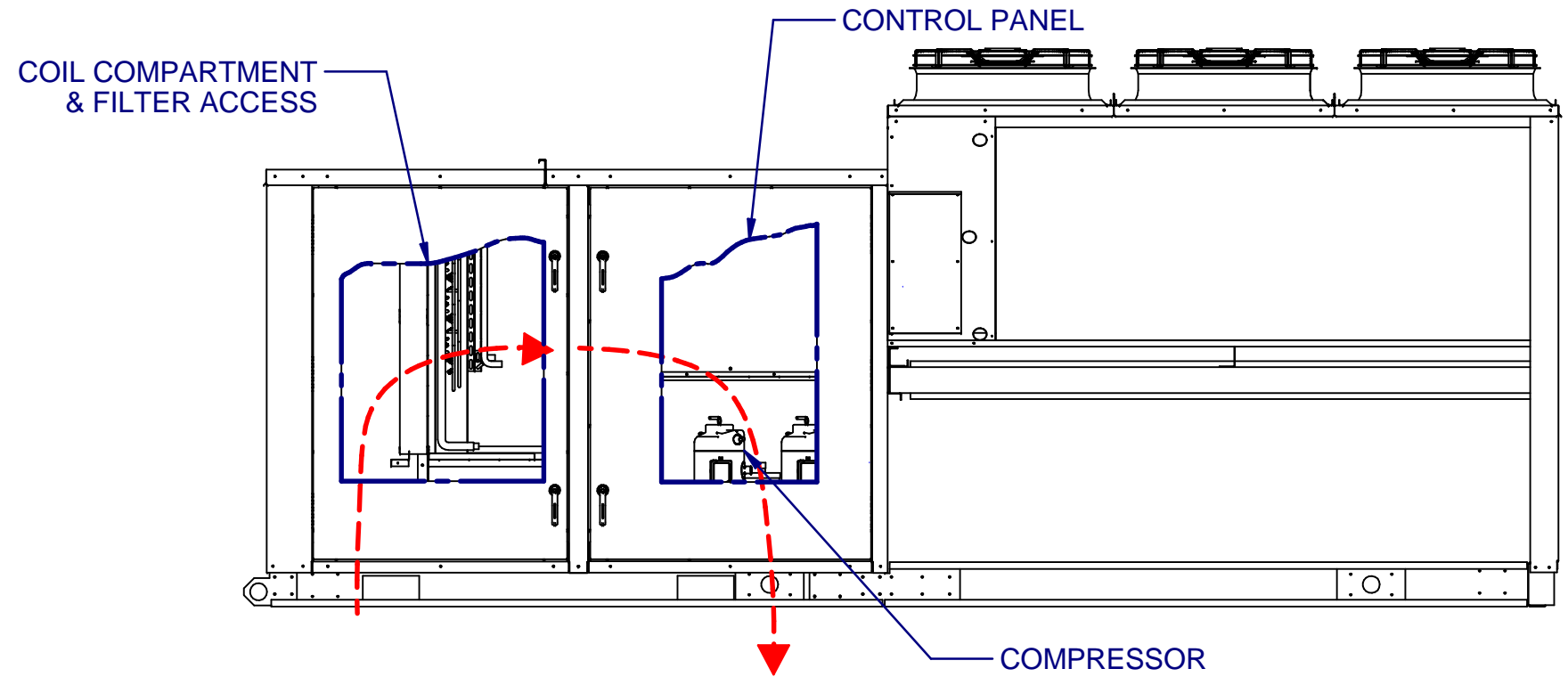

TOP PLAN VIEW
CONDENSING SIDE
NOT SHOWN

DRAWING NUMBER: 05041-2536-5	11/8/2016
TITLE: PR C6 CAB NO EXH	1 OF 1